



iviceversa
Soluciones
Gráficas



| | |
|------------------------|-----|
| ALUMINIUM FRAMES | 240 |
| LIGHT BOXES | 272 |
| MENU STAND | 281 |
| MENU BOARD | 284 |
| TABLET STAND | 286 |
| LECTERNS | 288 |
| BROCHURE STAND | 290 |
| BROCHURE WALL | 303 |
| STEEL BOARDS | 304 |
| STEEL BOARDS A-BOARD | 306 |

LUBLIN

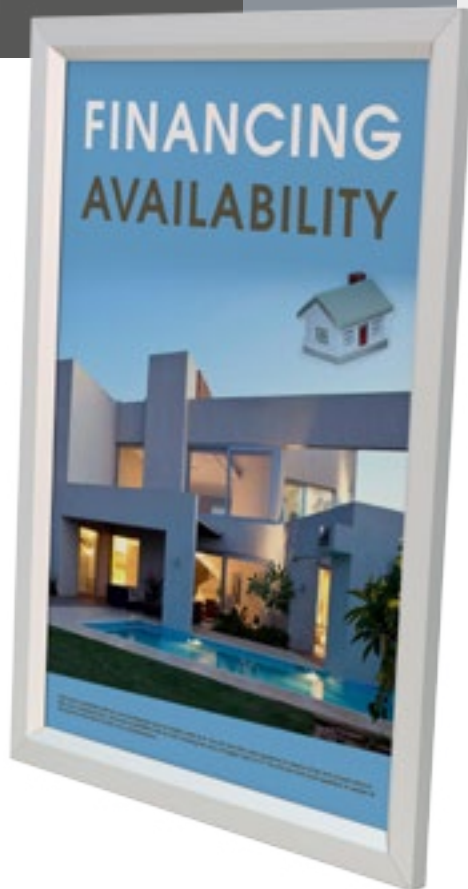

opening on the narrower side

quick and simple poster change

Frame done in anodized aluminium

INFORMATION



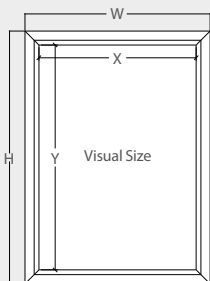

* W: Width H: Height D: Depth *mm

The Lublin frame is made of anodized aluminium. The change of graphic is really fast and easy, just insert your posters or graphics through the groove on the narrower side of the frame, this way, updating a presentation takes only a few seconds. Also, the screws and hangers for wall mounting are included. Lublin frame is ideal for restaurants, supermarkets, banks, movies theatres, airports, malls or any other location requiring frequent changes of posters.



LUBLIN

* W: Width H: Height D: Depth *mm

| Ref. | Graphic Size | Visual (X-Y) | External (WxHxD) | Profile | Packing (QTY) | N.W | G.W | C.B.M | Size (WxHxD) |  |
|--------|--------------|--------------|------------------|---|---------------|-------|--------|--------|--------------|---|
| 10.594 | A4 | 203x288 | 233x318x11 |  | 1 | 0.3kg | 0.4kg | 0.0020 | 325x245x25 | |
| 10.593 | A3 | 290x411 | 320x441x11 |  | 1 | 0.5kg | 0.65kg | 0.0037 | 450x332x25 | |
| 10.588 | A2 | 454x626 | 404x576x15 |  | 1 | 1kg | 1.3kg | 0.0074 | 633x466x25 | |
| 10.587 | A1 | 628x872 | 578x822x15 |  | 1 | 1.7kg | 2.25kg | 0.0135 | 880x640x24 | |

INFORMATION

The Gavarnie aluminum frame features a tension clip holder system. It can be mounted vertically or horizontally and updating a poster takes only a few seconds. 4 clips and 2 holders are included. Ideal for 2 way visibility places.



with clip holders

GAVARNIE

double sided



GAVARNIE

* W: Width H: Height D: Depth *mm

| Ref. | Graphic Size | External (WxHxD) | Packing (QTY) | N.W | G.W | C.B.M | Size (WxHxD) |  |
|--------|--------------|------------------|---------------|--------|--------|--------|--------------|---|
| 10.508 | A4 | 310x397 | 1 | 0.05kg | 0.5kg | 0.0009 | 80x380x30 | |
| 10.507 | A3 | 397x520 | 1 | 0.10kg | 0.55kg | 0.0012 | 80x510x30 | |
| 10.506 | A2 | 520x694 | 1 | 0.15kg | 1.65kg | 0.0016 | 80x680x30 | |
| 10.505 | A1 | 694x941 | 1 | 0.25kg | 0.75kg | 0.0022 | 80x940x30 | |
| 10.509 | A0 | 941x1289 | 1 | 0.30kg | 1.05kg | 0.0030 | 80x1280x30 | |

ALUMINIUM FRAMES | Click Frames

EN The Click Frames are made of anodized aluminum with highly resistant extruded molding. Simple to mount due to its "click" closing system.

FR Cadres en aluminium anodisé avec moulure extrudé très résistant. Facile à monter grâce à son système "click". Existe en simple ou double face.

PT Moldura de alumínio anodizado com perfil extrusionado de alta qualidade. Simples de utilizar graças ao seu sistema de abertura click.

ES Marcos fabricados en aluminio anodizado con moldura extrusionada de gran resistencia. De fácil montaje gracias al sistema de cierre "click".

ECONOMIC

MARACAY

NEW

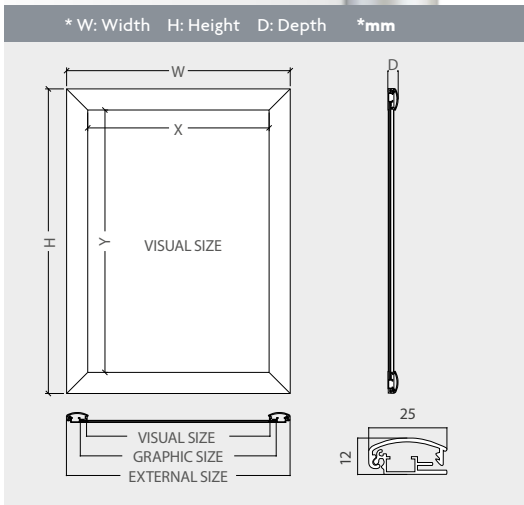

INFORMATION

The Maracay frame is economically priced because the profile is thinner and lightweight than other frames. Once this display is wall mounted though there is virtually no difference. Anti-reflective cover and screws are included. Perfect for restaurants, retail stores, community centers, theatres, airports, supermarkets.

| MARACAY A4 | | | | | |
|---------------|------------------|--------------|------------------|--------|--------------|
| | QTY | N.W | G.W | C.B.M | Size (WxHxD) |
| Packing | 10 | 0.4kg | 5.1kg | 0.0205 | 355x210x275 |
| | | Visual (X-Y) | External (WxHxD) | | |
| Product | 196x282 | 246x332x13 | | | |
| 14.124 | Graphic Size: A4 | | | | |

| MARACAY A1 | | | | | |
|---------------|------------------|--------------|------------------|--------|--------------|
| | QTY | N.W | G.W | C.B.M | Size (WxHxD) |
| Packing | 5 | 1.5kg | 11.7kg | 0.0726 | 910x120x665 |
| | | Visual (X-Y) | External (WxHxD) | | |
| Product | 587x838 | 637x888x13 | | | |
| 14.121 | Graphic Size: A1 | | | | |

| MARACAY A3 | | | | | |
|---------------|------------------|--------------|------------------|--------|--------------|
| | QTY | N.W | G.W | C.B.M | Size (WxHxD) |
| Packing | 10 | 0.57kg | 8.2kg | 0.0363 | 480x210x360 |
| | | Visual (X-Y) | External (WxHxD) | | |
| Product | 284x409 | 334x507x13 | | | |
| 14.123 | Graphic Size: A3 | | | | |

| MARACAY H700 | | | | | |
|---------------|-------------------------|--------------|------------------|--------|--------------|
| | QTY | N.W | G.W | C.B.M | Size (WxHxD) |
| Packing | 10 | 1.22kg | 14.7kg | 0.0910 | 760x210x570 |
| | | Visual (X-Y) | External (WxHxD) | | |
| Product | 488x694 | 538x744x13 | | | |
| 14.126 | Graphic Size: 500x700mm | | | | |

| MARACAY A2 | | | | | |
|---------------|------------------|--------------|------------------|--------|--------------|
| | QTY | N.W | G.W | C.B.M | Size (WxHxD) |
| Packing | 10 | 0.91kg | 13.2kg | 0.0672 | 660x210x485 |
| | | Visual (X-Y) | External (WxHxD) | | |
| Product | 406x587 | 456x637x13 | | | |
| 14.122 | Graphic Size: A2 | | | | |

| MARACAY H1000 | | | | | |
|---------------|--------------------------|--------------|------------------|--------|--------------|
| | QTY | N.W | G.W | C.B.M | Size (WxHxD) |
| Packing | 5 | 1.7kg | 12.9kg | 0.0979 | 1060x120x770 |
| | | Visual (X-Y) | External (WxHxD) | | |
| Product | 693x986 | 743x1036x13 | | | |
| 14.125 | Graphic Size: 700x1000mm | | | | |



ANADIA

INFORMATION

* W: Width H: Height D: Depth

The Anadia frame is constructed from aluminum and has a matte silver finish. Just beneath the extruded aluminum frame sides are spring clips that are responsible for the Click spring-loaded action. Once they are pressed between the face frame and internal channel, instant spring-loaded tension is achieved. Insert your posters or graphics on top of the back panel, replace the lens, and flip the sides down to hold everything in place, so updating a presentation takes only a few seconds. It can be mounted vertically or horizontally, depending on your sign or advertisement. We supply this frame with the necessary screws and hangers for wall mounting. This Frame is perfect for being used in restaurants, retail stores, community centers, movie theatres, airports, supermarkets, banks or any other location requiring frequent changes of advertisements.

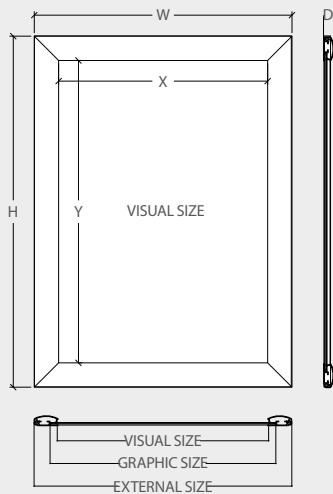

| ANADIA | | | | | * W: Width | H: Height | D: Depth | *mm | |
|----------|--------------|--------------|------------------|---|---------------|-----------|----------|-------------|--------------|
| Ref. | Graphic Size | Visual (X-Y) | External (WxHxD) | Profile | Packing (QTY) | N.W | G.W | C.B.M | Size (WxHxD) |
| * 10.314 | A4 | 199x286 | 237x324x12.50 |  | 1 | 0.4kg | 0.5kg | 0.024 | 270x350x25 |
| * 10.315 | A3 | 286x409 | 324x477x12.50 | | 1 | 0.7kg | 0.85kg | 0.061 | 365x480x35 |
| * 10.316 | A2 | 409x583 | 447x621x12.50 | | 1 | 1kg | 1.3kg | 0.067 | 475x645x22 |
| * 10.317 | 500x700 | 489x689 | 527x727x12.50 | | 1 | 1.3kg | 1.7kg | 0.0104 | 560x745x25 |
| * 10.214 | A4 | 190x278 | 242x329x12 |  | 1 | 0.45kg | 0.55kg | 0.0024 | 270x350x25 |
| * 10.213 | A3 | 278x401 | 329x452x12 | | 1 | 0.65kg | 0.85kg | 0.061 | 365x480x35 |
| * 10.212 | A2 | 401x575 | 452x626x12 | | 1 | 1.05kg | 1.35kg | 0.067 | 475x645x22 |
| * 10.215 | 500x700 | 480x680 | 532x732x12 | | 1 | 1.4kg | 1.8kg | 0.0104 | 560x745x25 |
| * 10.290 | A3 | 275x398 | 339x462x13.3 |  | 1 | 0.8kg | 1.05kg | 0.0061 | 365x480x35 |
| * 10.291 | A2 | 398x572 | 462x636x13.3 | | 1 | 1.2kg | 1.6kg | 0.0067 | 475x645x22 |
| * 10.292 | A1 | 572x819 | 663x884x13.3 | | 1 | 2kg | 2.45kg | 0.0143 | 645x886x25 |
| * 10.293 | 500x700 | 478x678 | 542x742x13.3 | | 1 | 1.5kg | 2kg | 0.0104 | 560x745x25 |
| * 10.294 | 700x1000 | 678x978 | 742x1042x13.3 | 1 | 2.55kg | 3.25kg | 0.0197 | 1075x780x25 | |
| * 10.296 | A0 | 821x1169 | 905x1253x14.5 |  | 1 | 4kg | 5.04kg | 0.0291 | 1265x920x25 |
| * 10.295 | 700x1000 | 680x980 | 764x1064x14.5 | | 1 | 3kg | 3.75kg | 0.0197 | 1075x780x25 |
| * 10.297 | 1000x1400 | 980x1380 | 1064x1464x14.5 | | 1 | 5.55kg | 6.7kg | 0.0398 | 1475x1080x25 |



ANADIA DOUBLE-SIDED



silver anodized
aluminium
finish

INFORMATION * W: Width H: Height D: Depth

The Double-sided Anadia frame is constructed from aluminum and has a matte silver finish. It can be mounted vertically or horizontally, depending on your sign or advertisement. We supply this frame with the necessary screws and hangers for hanging. Insert your posters or graphics on top of the back panel, replace the lens, and flip the sides down to hold everything in place, so updating a presentation takes only a few seconds. This frame features 2 ways visibility, increasing advertisement exposure. Ideal for hanging in a storefront window to advertise the passersby and customers within their institution, also this frame has a location flexibility, so users are no longer restricted to walls for posting signage. Hanging signage systems from the ceiling allow for placement overhead, in a central location. With this better space utilization, these window displays leave wall space open for exhibiting other advertisements or objects, so it's perfect for using in stores, community centers, airports, supermarkets, etc.

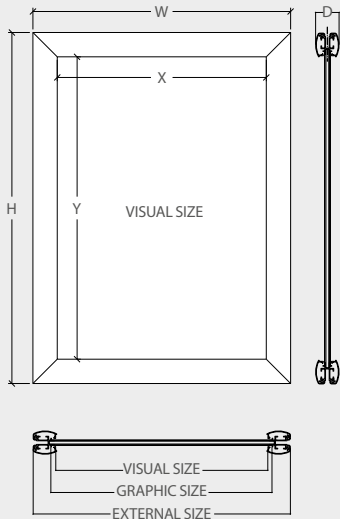

double
sided

with
anti-reflective
plastic

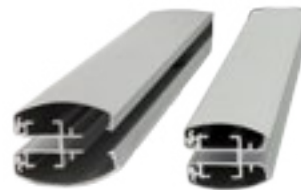

42mm

32mm

supplied
with
hangers

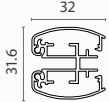
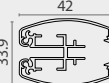

| ANADIA DOUBLE-SIDED | | | | | | | | | | | * W: Width | H: Height | D: Depth | *mm |
|---------------------|--------------|--------------|------------------|---|---------------|--------|--------|--------|--------------|--|------------|-----------|----------|-----|
| Ref. | Graphic Size | Visual (X-Y) | External (WxHxD) | Profile | Packing (QTY) | N.W | G.W | C.B.M | Size (WxHxD) | | | | | |
| * 10.299 | A3 | 283x406 | 347x470x31.6 |  | 1 | 1.25kg | 1.6kg | 0.0061 | 480x365x35 | | | | | |
| * 10.300 | A2 | 406x580 | 470x664x31.6 | | 1 | 1.85kg | 2.15kg | 0.0127 | 485x655x40 | | | | | |
| * 10.302 | A1 | 580x827 | 644x891x31.6 | | 1 | 2.8kg | 3.25kg | 0.0235 | 660x890x40 | | | | | |
| * 10.303 | 500x700 | 486x686 | 550x750x31.6 | | 1 | 2.3kg | 2.8kg | 0.0172 | 565x760x40 | | | | | |
| * 10.562 | A0 | 807x1155 | 891x1239x33.9 |  | 1 | 4.7kg | 6.2kg | 0.0430 | 905x1250x38 | | | | | |
| * 10.566 | 700x1000 | 666x966 | 750x1050x33.9 | | 1 | 4kg | 4.85kg | 0.0323 | 765x1055x40 | | | | | |

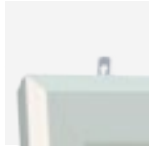

LIMA

INFORMATION

* W: Width H: Height D: Depth

The Lima frame is constructed from aluminum and has a matte silver finish. Just beneath the extruded aluminum frame sides are spring clips that are responsible for the Click spring-loaded action. Once they are pressed between the face frame and internal channel, instant spring-loaded tension is achieved. Insert your posters or graphics on top of the back panel, replace the lens, and flip the sides down to hold everything in place, so updating a presentation takes only a few seconds. It can be mounted vertically or horizontally, depending on your sign or advertisement. We supply this frame with the necessary screws and hangers for wall mounting. This Frame is perfect for being used in restaurants, retail stores, community centers, movie theatres, airports, supermarkets, banks or any other location requiring frequent changes of advertisements.

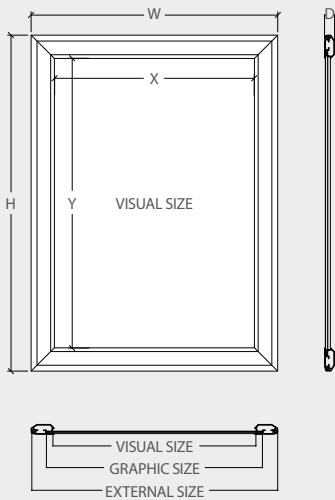

with anti-reflective plastic

silver anodized aluminium finish



supplied with hangers



| LIMA | | | | | * W: Width H: Height D: Depth | | | | *mm | |
|----------|--------------|--------------|------------------|---|-------------------------------|--------|--------|-------------|--------------|--|
| Ref. | Graphic Size | Visual (X-Y) | External (WxHxD) | Profile | Packing (QTY) | N.W | G.W | C.B.M | Size (WxHxD) | |
| * 10.210 | A4 | 199x286 | 237x324x11.95 |  | 1 | 0.4kg | 0.5kg | 0.0024 | 270x350x25 | |
| * 10.209 | A3 | 286x409 | 324x477x11.95 | | 1 | 0.7kg | 0.85kg | 0.0061 | 365x480x35 | |
| * 10.208 | A2 | 409x583 | 447x621x11.95 | | 1 | 1kg | 1.3kg | 0.0067 | 475x645x22 | |
| * 10.211 | 500x700 | 489x689 | 527x727x11.95 | | 1 | 1.3kg | 1.7kg | 0.0104 | 560x745x25 | |
| * 10.260 | A4 | 190x278 | 242x329x11.5 |  | 1 | 0.45kg | 0.55kg | 0.0024 | 270x350x25 | |
| * 10.259 | A3 | 278x401 | 329x452x11.5 | | 1 | 0.65kg | 0.85kg | 0.0061 | 365x480x35 | |
| * 10.258 | A2 | 401x575 | 452x626x11.5 | | 1 | 1.05kg | 1.35kg | 0.0067 | 475x645x22 | |
| * 10.261 | 500x700 | 480x680 | 532x732x11.5 | 1 | 1.4kg | 1.8kg | 0.0104 | 560x745x25 | | |
| * 10.262 | A3 | 275x398 | 339x462x13.75 |  | 1 | 0.8kg | 1.05kg | 0.0061 | 365x480x35 | |
| * 10.263 | A2 | 398x572 | 462x636x13.75 | | 1 | 1.2kg | 1.6kg | 0.0067 | 475x645x22 | |
| * 10.264 | A1 | 572x819 | 663x884x13.75 |  | 1 | 2kg | 2.45kg | 0.0143 | 645x886x25 | |
| * 10.266 | 500x700 | 478x678 | 542x742x13.75 | | 1 | 1.5kg | 2kg | 0.0104 | 560x745x25 | |
| * 10.267 | 700x1000 | 678x978 | 742x1042x13.75 | 1 | 2.6kg | 3.5kg | 0.0197 | 1075x780x25 | | |
| * 10.270 | A0 | 821x1169 | 905x1253x13.75 |  | 1 | 4kg | 5.04kg | 0.0291 | 1265x920x25 | |
| * 10.272 | 700x1000 | 680x980 | 764x1064x13.75 | | 1 | 3kg | 3.75kg | 0.0197 | 1075x780x25 | |
| * 10.268 | 1000x1400 | 980x1380 | 1064x1464x13.75 | | 1 | 5.5kg | 6.7kg | 0.0398 | 1475x1080x25 | |

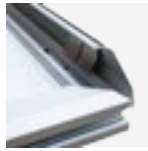

LIMA DOUBLE-SIDED



with anti-reflective plastic

INFORMATION

* W: Width H: Height D: Depth

The Double-sided Lima frame is constructed from aluminum and has a matte silver finish. It can be mounted vertically or horizontally, depending on your sign or advertisement. We supply this frame with the necessary screws and hangers for hanging. Insert your posters or graphics on top of the back panel, replace the lens, and flip the sides down to hold everything in place, so updating a presentation takes only a few seconds. This frame features 2 ways visibility, increasing advertisement exposure. Ideal for hanging in a storefront window to advertise the passersby and customers within their institution, also this frame has a location flexibility, so users are no longer restricted to walls for posting signage. So hanging signage systems from the ceiling allow for placement overhead, in a central location. With this better space utilization, these window displays leave wall space open for exhibiting other advertisements or objects, so it's perfect for using in stores, community centers, airports, supermarkets, etc.

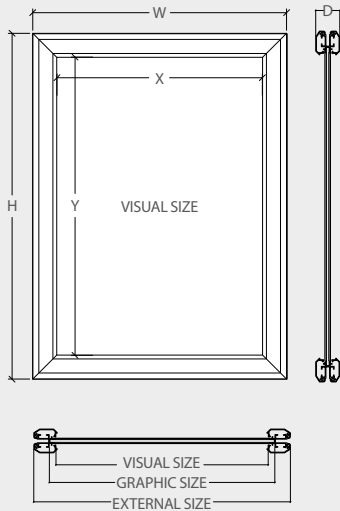

double sided





silver anodized aluminium finish



supplied with hangers



LIMA DOUBLE-SIDED

| Ref. | Graphic Size | Visual (X-Y) | External (WxHxD) | Profile | Packing (QTY) | N.W | G.W | C.B.M | Size (WxHxD) | *mm |
|----------|--------------|--------------|------------------|---|---------------|--------|--------|--------|--------------|-----|
| * 10.563 | A3 | 283x406 | 347x470x32.39 |  | 1 | 1.25kg | 1.6kg | 0.0061 | 480x365x35 | |
| * 10.564 | A2 | 406x580 | 470x664x32.39 | | 1 | 1.85kg | 2.15kg | 0.0127 | 485x655x40 | |
| * 10.565 | A1 | 580x827 | 644x891x32.39 | | 1 | 2.8kg | 3.25kg | 0.0235 | 660x890x40 | |
| * 10.289 | 500x700 | 486x686 | 550x750x32.39 | | 1 | 2.3kg | 2.8kg | 0.0172 | 565x760x40 | |
| * 10.257 | A0 | 807x1155 | 891x1239x32.39 |  | 1 | 4.7kg | 6.2kg | 0.0430 | 905x1250x38 | |
| * 10.560 | 700x1000 | 666x966 | 750x1050x32.39 | | 1 | 4kg | 4.85kg | 0.0323 | 765x1055x40 | |



LIMA LOCKABLE



with anti-reflective plastic

INFORMATION

* W: Width H: Height D: Depth

The Lima frame is constructed from aluminum and has a matte silver finish. Just beneath the extruded aluminum frame sides are spring clips that are responsible for the Click spring-loaded action. Insert your posters or graphics on top of the back panel, replace the lens, and flip the sides down to hold everything in place, so updating a presentation takes only a few seconds. It can be mounted vertically or horizontally, depending on your sign or advertisement. The front-loading frame can be secured shut with an Allen key to keep posters protected. We supply this frame with the necessary screws and hangers for wall mounting. This Frame is perfect for being used in restaurants, retail stores, community centers, movie theatres, airports, supermarkets, banks or any other location requiring frequent changes of advertisements.

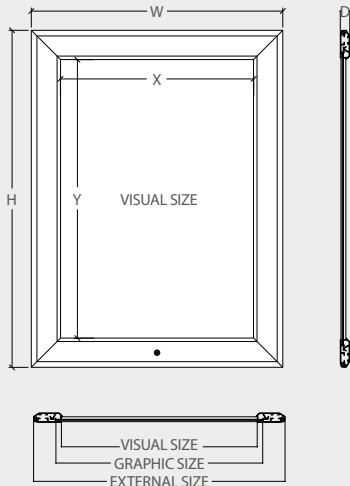

lockable



42mm

supplied with hangers



LIMA LOCKABLE

* W: Width H: Height D: Depth

*mm

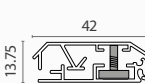
| Ref. | Graphic Size | Visual (X-Y) | External (WxHxD) | Profile | Packing (QTY) | N.W | G.W | C.B.M | Size (WxHxD) |  |
|--------|--------------|--------------|------------------|---|---------------|--------|--------|--------|--------------|---|
| 10.280 | A1 | 574x821 | 658x905x13.75 |  | 1 | 2.3kg | 3.1kg | 0.0153 | 672x912x25 | |
| 10.281 | A0 | 821x1169 | 905x1253x13.75 | | 1 | 4kg | 5.04kg | 0.0291 | 1265x920x65 | |
| 10.282 | 500x700 | 480x680 | 564x764x13.75 | | 1 | 1.8kg | 2.35kg | 0.0112 | 580x771x25 | |
| 10.283 | 700x1000 | 680x980 | 764x1064x13.75 | | 1 | 3kg | 3.75kg | 0.0191 | 1075x780x25 | |
| 10.278 | 1000x1400 | 980x1380 | 1064x1464x13.75 | | 1 | 5.55kg | 6.7kg | 0.0398 | 1475x1080x25 | |

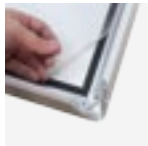

LIMA
WATERPROOF



waterproof

with
anti-reflective
plastic

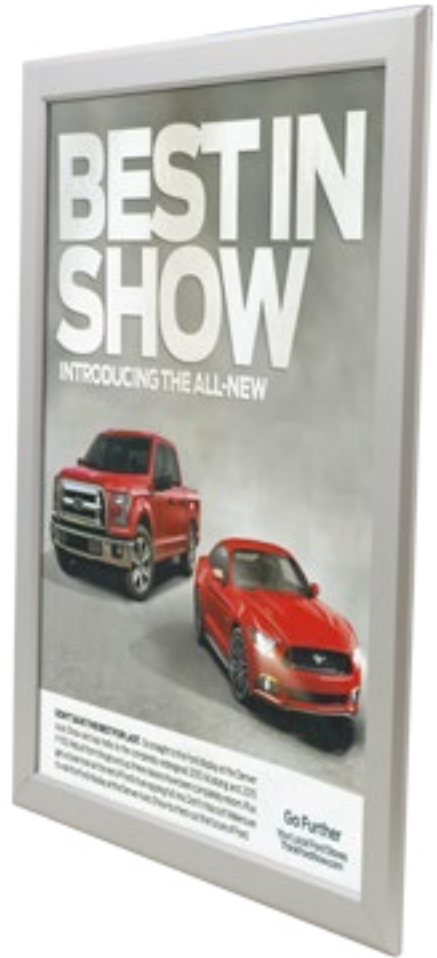

42mm



supplied
with hangers

INFORMATION

* W: Width H: Height D: Depth

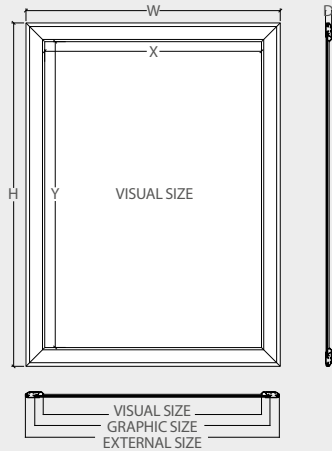

The Lima frame is constructed from aluminum and has a matte silver finish. Just beneath the extruded aluminum frame sides are spring clips that are responsible for the Click spring-loaded action. Insert your posters or graphics on top of the back panel, replace the lens, and flip the sides down to hold everything in place, so updating a presentation takes only a few seconds. It can be mounted vertically or horizontally, depending on your sign or advertisement. The front-loading frame can be secured shut with an Allen key to keep posters protected. We supply this frame with the necessary screws and hangers for wall mounting. This Frame is perfect for being used in restaurants, retail stores, community centers, movie theatres, airports, supermarkets, banks or any other location requiring frequent changes of advertisements.



LIMA WATERPROOF

* W: Width H: Height D: Depth

*mm

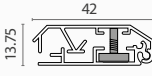
| Ref. | Graphic Size | Visual (X-Y) | External (WxHxD) | Profile | Packing (QTY) | N.W | G.W | C.B.M | Size (WxHxD) |   |
|----------|--------------|--------------|------------------|---|---------------|--------|--------|--------|--------------|---|
| * 10.285 | A1 | 580x827 | 664x911x13.75 |  | 1 | 2kg | 2.5kg | 0.0153 | 672x912x25 | |
| * 10.286 | A0 | 827x1175 | 911x1259x13.75 | | 1 | 4kg | 5.04kg | 0.0291 | 1265x920x25 | |
| * 10.287 | 500x700 | 486x686 | 570x770x13.75 | | 1 | 1.65kg | 2.01kg | 0.0104 | 560x745x25 | |
| * 10.288 | 700x1000 | 686x986 | 770x1070x13.75 | | 1 | 3.05kg | 3.48kg | 0.0191 | 1075x780x25 | |
| * 10.561 | 1000x1400 | 986x1386 | 1070x1470x13.75 | | 1 | 5.55kg | 6.7kg | 0.0398 | 1475x1080x25 | |



SERENA



32mm



supplied with hangers



with anti-reflective plastic cover

INFORMATION

* W: Width H: Height D: Depth *mm

The Serena aluminum frame features a stylish bicolor design. It has a 32mm width profile which features click closing system. Just beneath the extruded aluminum frame sides are spring clips that are responsible for the Click spring-loaded action. Once they are pressed between the face frame and internal channel, instant spring-loaded tension is achieved. Insert your posters or graphics on top of the back panel, replace the lens, and flip the sides down to hold everything in place, so updating a presentation takes only a few seconds. It can be mounted vertically or horizontally, depending on your sign or advertisement. Featuring 5 standard sizes available. Due to its elegant appearance the single-sided frame Serena is ideal for restaurants, hotels, theatres, offices, malls or any other location requiring a distinctive look on the frames or a frequent changes of posters. Also, Protective anti-reflection cover, screws and hangers are included.

* W: Width H: Height D: Depth *mm

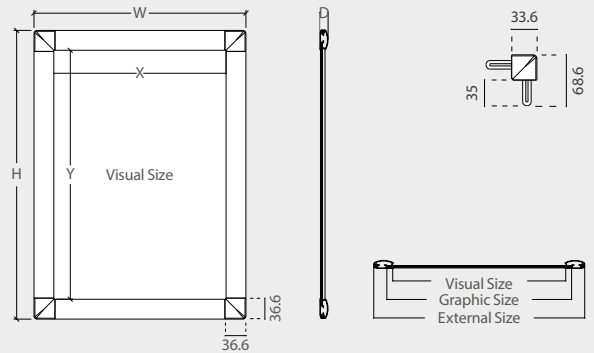

SERENA

* W: Width H: Height D: Depth *mm

| Ref. | Graphic Size | Visual (X-Y) | External (WxHxD) | Profile | Packing (QTY) | N.W | G.W | C.B.M | Size (WxHxD) |
|--------|--------------|--------------|------------------|---|---------------|--------|--------|--------|--------------|
| 10.405 | A4 | 188x275 | 252x339x13.35 |  | 1 | 0.4kg | 0.5kg | 0.0024 | 270x25x350 |
| 10.404 | A3 | 275x398 | 339x462x13.35 | | 1 | 0.7kg | 0.95kg | 0.0042 | 475x22x355 |
| 10.403 | A2 | 398x572 | 462x636x13.35 | | 1 | 1.05kg | 1.45kg | 0.0067 | 475x22x645 |
| 10.408 | 500x700 | 478x678 | 542x742x13.35 | | 1 | 1.35kg | 1.85kg | 0.0104 | 560x25x745 |
| 10.163 | 700x1000 | 678x978 | 742x1042x13.35 | | 1 | 2.35kg | 3.05kg | 0.0197 | 1075x25x780 |

GET 6 CORNER COLORS WITH 1 FRAME!



INCLUDES 4 GREY CORNERS AND 20 COLORED COVERS

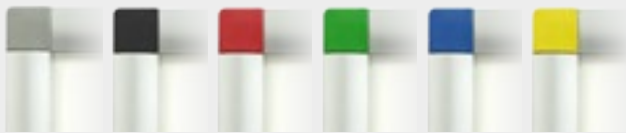

INFORMATION * W: Width H: Height D: Depth *mm

The Rainbow aluminum frame features 4 grey corners + 20 colored covers. It has a 32mm width profile which features click closing system. Just beneath the extruded aluminum frame sides are spring clips that are responsible for the Click spring-loaded action. Once they are pressed between the face frame and internal channel, instant spring-loaded tension is achieved. Insert your posters or graphics on top of the back panel, replace the lens, and flip the sides down to hold everything in place, so updating a presentation takes only a few seconds. It can be mounted vertically or horizontally, depending on your sign or advertisement. Featuring 5 standard sizes available. Due to its elegant appearance the single-sided frame Rainbow is ideal for restaurants, hotels, theatres, offices, malls or any other location requiring a distinctive look on the frames or a frequent changes of posters. Also, Protective anti-reflection cover, screws and hangers are included.

* W: Width H: Height D: Depth *mm

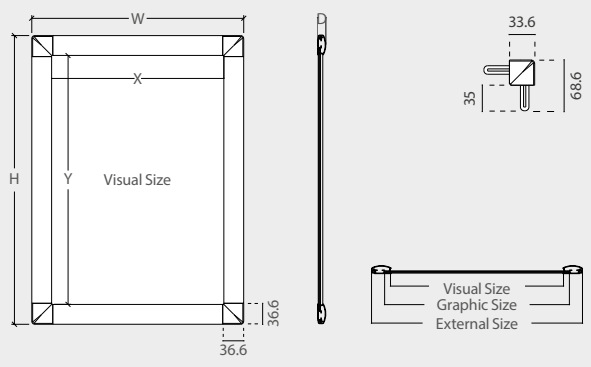

RAINBOW FRAME

NEW



with anti-reflective plastic cover



supplied with hangers

32mm

RAINBOW * W: Width H: Height D: Depth *mm

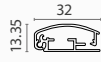
| Ref. | Graphic Size | Visual (X-Y) | External (WxHxD) | Profile | Packing (QTY) | N.W | G.W | C.B.M | Size (WxHxD) |
|--------|--------------|--------------|------------------|---|---------------|--------|--------|--------|--------------|
| 13.590 | A4 | 188x275 | 252x339x13.35 |  | 1 | 0.4kg | 0.5kg | 0.0024 | 270x25x350 |
| 13.591 | A3 | 275x398 | 339x462x13.35 | | 1 | 0.7kg | 0.95kg | 0.0042 | 475x22x355 |
| 13.592 | A2 | 398x572 | 462x636x13.35 | | 1 | 1.05kg | 1.45kg | 0.0067 | 475x22x645 |
| 13.593 | 500x700 | 478x678 | 542x742x13.35 | | 1 | 1.35kg | 1.85kg | 0.0104 | 560x25x745 |
| 13.754 | 700x1000 | 678x978 | 742x1042x13.35 | | 1 | 2.35kg | 3.05kg | 0.0197 | 1075x25x780 |



ISCAR
COVER FRAME



with
anti-reflective
plastic

* W: Width H: Height D: Depth *mm

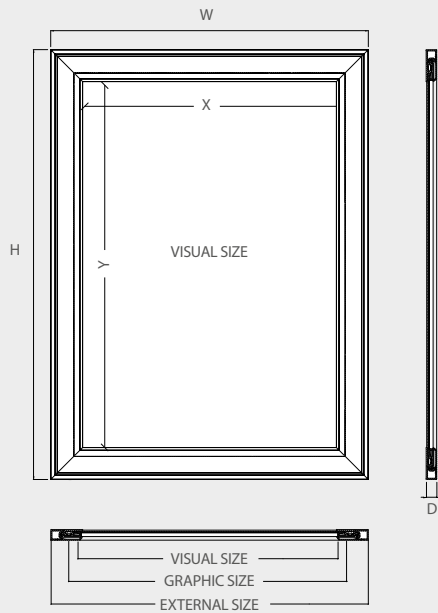

supplied with
hangers and
screws

INFORMATION

The Iscar aluminum frame features a stylish design with double-framed appearance. It has a 34.5mm width profile which features click closing system. Just beneath the extruded aluminum frame sides are spring clips that are responsible for the Click spring-loaded action. Once they are pressed between the face frame and internal channel, instant spring-loaded tension is achieved. Insert your posters or graphics on top of the back panel, replace the lens, and flip the sides down to hold everything in place, so updating a presentation takes only a few seconds. It can be mounted vertically or horizontally, depending on your sign or advertisement. Featuring 5 standard sizes available. Due to its elegant appearance the double-sided frame Iscar is ideal for restaurants, hotels, theatres, offices, malls or any other location requiring a distinctive look on the frames or a frequent changes of posters. Also, Protective anti-reflection cover, screws and hangers are included.



| ISCAR | | | | | * W: Width H: Height D: Depth *mm | | | | |
|--------|--------------|--------------|------------------|---------|-----------------------------------|--------|--------|--------|--------------|
| Ref. | Graphic Size | Visual (X-Y) | External (WxHxD) | Profile | Packing (QTY) | N.W | G.W | C. B.M | Size (WxHxD) |
| 13.635 | A3 | 278x401 | 346x471x11.5 | | 1 | 1.04kg | 1.19kg | 0.0044 | 485x365x25 |
| 13.636 | A2 | 401x575 | 471x645x11.5 | | 1 | 1.52kg | 1.78kg | 0.0080 | 660x485x25 |
| 13.637 | A1 | 575x822 | 645x892x11.5 | | 1 | 2.34kg | 2.78kg | 0.0149 | 905x660x25 |
| 13.638 | 500x700mm | 461x681 | 551x751x11.5 | | 1 | 1.87kg | 2.20kg | 0.0108 | 765x565x25 |
| 13.639 | 700x1000mm | 681x981 | 751x1051x11.5 | | 1 | 2.95kg | 3.54kg | 0.0204 | 1065x765x25 |

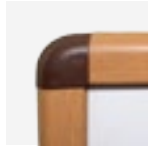

TRUJILLO

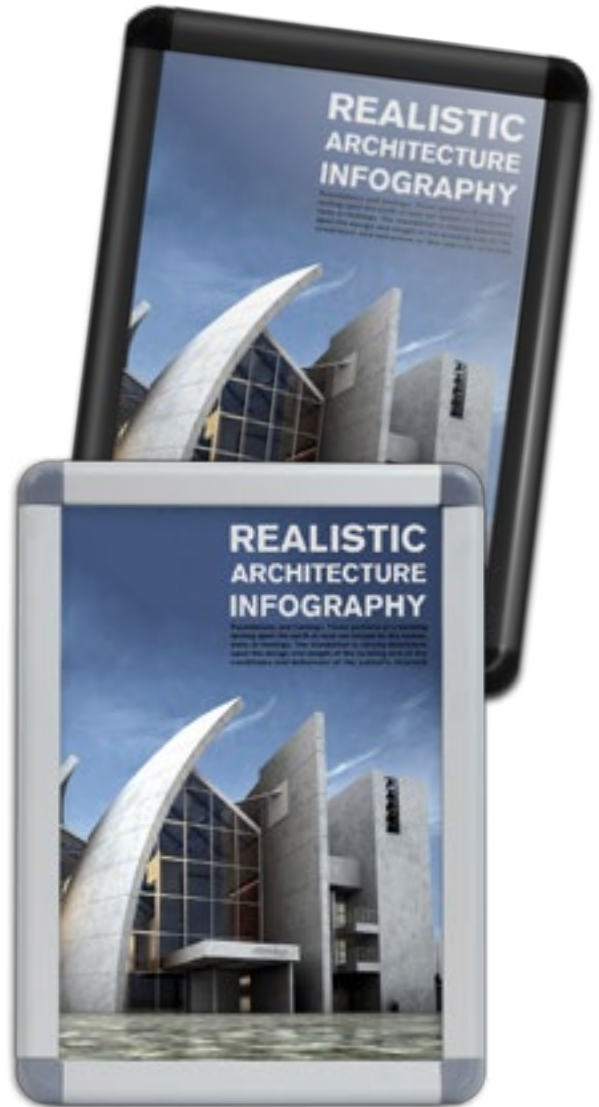

INFORMATION

* W: Width H: Height D: Depth *mm

The Trujillo aluminum frame features a stylish bicolor design with rounded corners. It can be mounted vertically or horizontally and updating a poster takes only a few seconds. 4 colors available upon request. Ideal for restaurants, markets, malls or any other location requiring frequent changes of posters. Screws and hangers included.

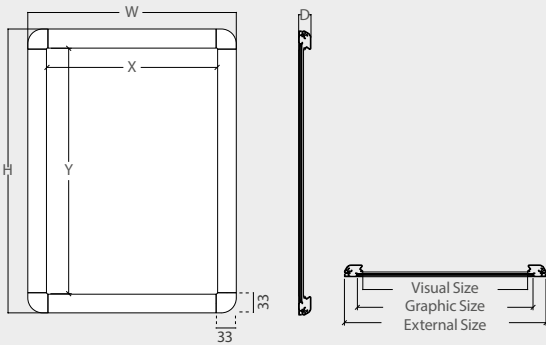

- Ral 3020
- Ral 5002
- Ral 6029
- Wood Color

Upon request. Mediante consulta.
Sur demande. Bajo pedido.



| TRUJILLO | | | | | | * W: Width | | H: Height | D: Depth | *mm |
|----------|--------------|--------------|------------------|---------|---------------|------------|--------|-----------|--------------|-----|
| Ref. | Graphic Size | Visual (X-Y) | External (WxHxD) | Profile | Packing (QTY) | N.W | G.W | C.B.M | Size (WxHxD) | |
| 10.131 | A3 | 278x402 | 344x468x20.3 | | 1 | 1kg | 1.2kg | 0.0061 | 365x480x35 | |
| 10.132 | A2 | 402x575 | 468x641x20.3 | | 1 | 1.65kg | 2.15kg | 0.0127 | 485x655x40 | |
| 10.133 | A1 | 575x822 | 641x888x20.3 | | 1 | 2.4kg | 3.2kg | 0.0235 | 660x890x40 | |
| 10.134 | A0 | 822x1170 | 888x1236x20.3 | | 1 | 4.4kg | 5.45kg | 0.0430 | 1250x905x38 | |
| 10.135 | 500x700 | 481x681 | 547x747x20.3 | | 1 | 1.95kg | 2.4kg | 0.0104 | 560x745x25 | |
| 10.136 | 700x1000 | 681x981 | 747x1047x20.3 | | 1 | 3.25kg | 4kg | 0.0323 | 765x1055x40 | |



ideal for
foamboard



5mm maximum
thickness of
graphic

TARNOW



supplied with corner
connections and
allen key

INFORMATION

* W: Width H: Height D: Depth *mm

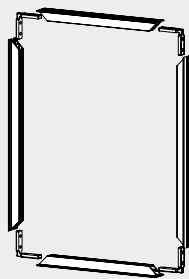
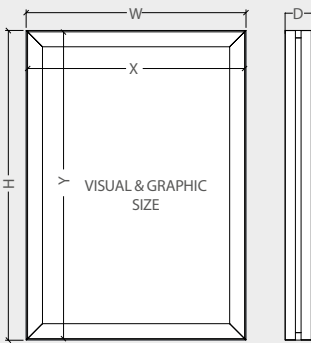

INCLUDED WITH EVERY FRAME:

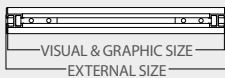
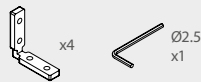



The Tarnow aluminum frame features a silver or a stunning black finished design for being used with foamboard graphics. It can be mounted vertically or horizontally and updating a poster is simple and fast. 7 standard sizes are available. Corner connections and Allen key are included. The maximum panel or foam thickness is 5mm. The Tarnow frame is ideal for restaurants, hotels, theatres, offices, malls or any other location requiring a distinctive look on the frames or a frequent changes of posters.

TARNOW

* W: Width H: Height D: Depth

*mm

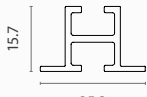
| Ref. | Graphic Size | Visual (X-Y) | External (WxHxD) | Profile | Packing (QTY) | N.W | G.W | C.B.M | Size (WxHxD) |   |
|--------|--------------|--------------|------------------|---|---------------|--------|--------|--------|--------------|---|
| 13.628 | A4 | 297x210 | 213x300x25.3 |  | 1 | 0.34kg | 0.42kg | 0.0025 | 315x230x35 | |
| 13.629 | A3 | 420x297 | 300x423x25.3 | | 1 | 0.45kg | 0.58kg | 0.0048 | 435x315x35 | |
| 13.630 | A2 | 594x420 | 423x597x25.3 | | 1 | 0.59kg | 0.82kg | 0.0094 | 610x440x35 | |
| 13.631 | A1 | 841x594 | 597x844x25.3 | | 1 | 0.80kg | 1.21kg | 0.0185 | 860x615x35 | |
| 13.632 | A0 | 1189x841 | 844x1192x25.3 | | 1 | 1.10kg | 1.89kg | 0.0309 | 1025x860x35 | |
| 13.633 | 500x700 | 500x700 | 503x703x25.3 | | 1 | 0.69kg | 1.01kg | 0.0130 | 715x520x35 | |
| 13.634 | 700x1000 | 700x1000 | 703x1003x25.3 | | 1 | 0.93kg | 1.5kg | 0.0256 | 1015x720x35 | |

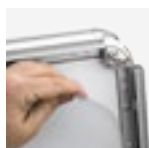

INFORMATION

* W: Width H: Height D: Depth * mm

This A-frame board is made of aluminum so it is lightweight and resistant to rusting. It has feet protection to avoid slipping and also a 30.5mm width profile with click system, so the graphic change is quick and simple. Also, it includes a weather resistant antireflection sheet so is also non-glare which allows it to be read under bright lights. With its 2-sided folding frame, Bayonne A-Board is ideal for advertising sales or special promotions outside your store.

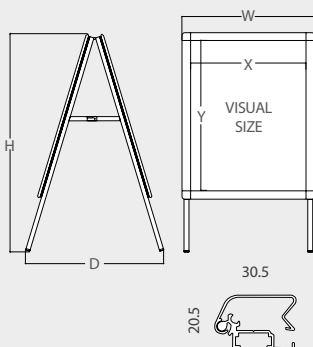

BAYONNE H700

* W: Width H: Height D: Depth * mm

| | QTY | N.W | G.W | C.B.M | Size (WxHxD) |
|---------|---------|--------------|------------------|-------|--------------|
| Packing | 1 | 4.85kg | 6.5kg | 0.068 | 509x1120x120 |
| | | Visual (X-Y) | External (WxHxD) | | |
| Product | 485x685 | | 545x1030x532 | | |

***10.804** Graphic Size: 500x700mm

BAYONNE H1000

* W: Width H: Height D: Depth * mm

| | QTY | N.W | G.W | C.B.M | Size (WxHxD) |
|---------|---------|--------------|------------------|-------|--------------|
| Packing | 1 | 7.64kg | 9.6kg | 0.127 | 795x1400x115 |
| | | Visual (X-Y) | External (WxHxD) | | |
| Product | 687x988 | | 745x1330x605 | | |

***10.805** Graphic Size: 700x1000mm

BAYONNE A1

* W: Width H: Height D: Depth * mm

| | QTY | N.W | G.W | C.B.M | Size (WxHxD) |
|---------|---------|--------------|------------------|-------|--------------|
| Packing | 1 | 6.7kg | 8.5kg | 0.101 | 695x1220x120 |
| | | Visual (X-Y) | External (WxHxD) | | |
| Product | 580x830 | | 640x1170x540 | | |

***13.145** Graphic Size: A1

BAYONNE A0

* W: Width H: Height D: Depth * mm

| | QTY | N.W | G.W | C.B.M | Size (WxHxD) |
|---------|----------|--------------|------------------|-------|--------------|
| Packing | 1 | 10.2kg | 12.45kg | 0.175 | 930x1575x120 |
| | | Visual (X-Y) | External (WxHxD) | | |
| Product | 825x1170 | | 885x1520x585 | | |

***13.146** Graphic Size: A0

CLICK BOARDS

| | |
|----|---|
| EN | Clickboards made of aluminium with plastic parts. Includes anti-reflective protector cover. Suitable for indoor or outdoor uses. |
| FR | Chevalet en aluminium avec cadre click. Antireflet inclus, idéal pour une utilisation intérieur ou extérieur. |
| PT | Expositores com um ou mais marcos. Disponível em uma face ou em dupla face. Perfis de alumínio. Pode ser usado no interior ou exterior. |
| ES | Caballetes fabricados en aluminio con partes plásticas. Incluye plástico protector de gráfica. Adecuados para uso exterior o interior. |

BAYONNE



ANTIREFLECTION SHEET



| | |
|----|--|
| EN | Antireflection sheet for snapframe. |
| FR | Antireflet pour cadres ou chevalets. |
| PT | Película anti-reflexo para marcos e cavaletes. |
| ES | Antireflex para marcos y caballetes. |

| Ref. | Size |
|----------------|-----------------|
| *10.952 | 500x700mm |
| *10.953 | 700x1000mm |
| *10.992 | A1 598x838mm |
| *10.993 | A0 838x1188mm |



NIZA

with PVC anti-glare poster cover

one sided



INFORMATION

* W: Width H: Height D: Depth * mm

This frame board is made of aluminum so it is lightweight and resistant to rusting. It has a 30.5mm width profile with click system, so the graphic change is quick and simple. With its single-sided folding frame, Niza A-Board is ideal for advertising outside your store, like restaurants, street stalls or supermarkets. It includes a weather resistant antireflection sheet so is also non-glare which allows it to be read under bright lights.

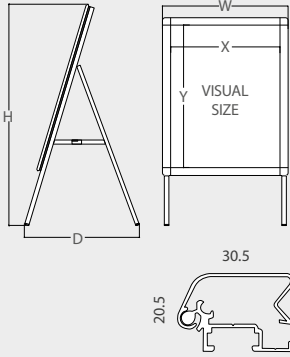

NIZA

* W: Width H: Height D: Depth * mm

| | QTY | N.W | G.W | C.B.M | Size (WxHxD) | |
|---------|---------|--------------|------------------|-------|--------------|--|
| Packing | 1 | 5kg | 7kg | 0.075 | 580x1080x120 | |
| | | Visual (X-Y) | External (WxHxD) | | | |
| Product | 485x685 | | 540x1060x440 | | | |

❁ 10.808

Graphic Size: 500x700mm



GRENOBLE



INFORMATION

* W: Width H: Height D: Depth * mm

Grenoble is a small dimensions A-frame board, which is made of aluminum so it is lightweight and resistant to rusting. It has a 32mm width profile with click system, so the graphic change is quick and simple. With its dimensions and 2-sided folding structure, Grenoble is ideal for advertising your upcoming events, shows, menu or last offers outside your shop. It includes a weather resistant antireflection sheet so is also non-glare which allows it to be read under bright lights.

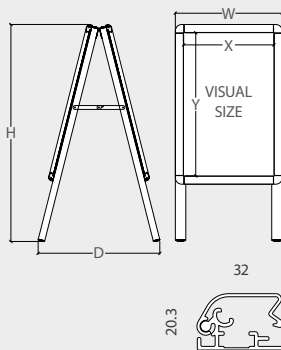

GRENOBLE

* W: Width H: Height D: Depth * mm

| | QTY | N.W | G.W | C.B.M | Size (WxHxD) | |
|---------|---------|--------------|------------------|--------|--------------|--|
| Packing | 1 | 4.3kg | 5kg | 0.0374 | 425x880x100 | |
| | | Visual (X-Y) | External (WxHxD) | | | |
| Product | 341x541 | | 404x815x456 | | | |

❁ 10.942

Graphic Size: 340x540mm



MERIDA

highly resistant

double sided



INFORMATION

* W: Width H: Height D: Depth *mm

This A-frame board is made of aluminum so it is lightweight and very resistant to rusting. It has feet protection to avoid slipping and also a 32mm width profile with click system, so the graphic change is quick and simple. Also it includes a weather resistant antireflection sheet so is also non-glare which allows it to be read under bright lights. With its 2-sided folding frame, Merida Click A-Board is ideal for advertising sales, promotions outside or inside your business.

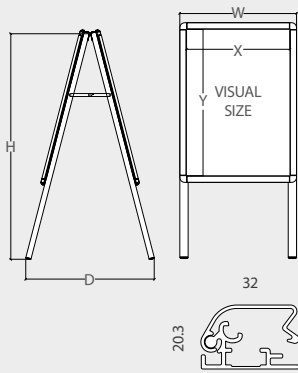

click system

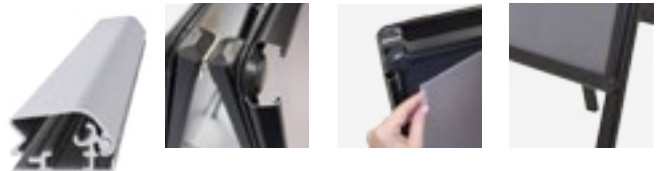



32mm

anti-reflective plastic



MERIDA A1

* W: Width H: Height D: Depth *mm

| | QTY | N.W | G.W | C.B.M | Size (WxHxD) |
|---|-----|--------------|------------------|-------|------------------|
| Packing | 1 | 7.92kg | 9.69kg | 0.098 | 660x1420x105 |
| | | Visual (X-Y) | External (WxHxD) | | |
| Product | | 575x822 | 638x1400x698 | | |
|  10.337 | | | | | |
|  10.119N | | | | | Graphic Size: A1 |



MERIDA H700

* W: Width H: Height D: Depth *mm

| | QTY | N.W | G.W | C.B.M | Size (WxHxD) |
|---|-----|--------------|------------------|-------|-------------------------|
| Packing | 1 | 5.64kg | 6.7kg | 0.072 | 575x1100x115 |
| | | Visual (X-Y) | External (WxHxD) | | |
| Product | | 481x681 | 544x1050x598 | | |
|  10.338 | | | | | Graphic Size: 500x700mm |
|  10.122N | | | | | |





MERIDA H1000

* W: Width H: Height D: Depth *mm

| | QTY | N.W | G.W | C.B.M | Size (WxHxD) |
|---|-----|--------------|------------------|-------|--------------------------|
| Packing | 1 | 8.94kg | 10.67kg | 0.127 | 765x1445x115 |
| | | Visual (X-Y) | External (WxHxD) | | |
| Product | | 681x981 | 744x1400x799 | | |
|  10.339 | | | | | Graphic Size: 700x1000mm |
|  10.124N | | | | | |

also more colors available



 Ral 3020  Ral 5002
 Ral 6029  Wood Color

Upon request.
Sur demande.
Mediante consulta.
Disponibile bajo pedido.



MONTANCHEZ



non-slip leveling feet

INFORMATION

* W: Width H: Height D: Depth * mm

This A-Board frame is made of aluminum over a steel structure so this way, its extra weight gives a great stability and it's very resistant to rusting. It has non-slip leveling feet and also a 42mm width profile with click system, so the graphic change is quick and simple. With its double-sided folding frame, Montanchez is designed especially for outdoor use so it's perfect for advertising sales and promotions outside your store. It includes a weather resistant antireflection sheet so is also non-glare which allows it to be read under bright lights.

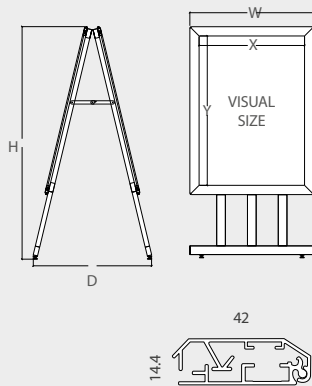

MONTANCHEZ H700

* W: Width H: Height D: Depth *mm

| | QTY | N.W | G.W | C.B.M | Size (WxHxD) |
|---------------|-----|---------|-------------------------|------------------|--------------|
| Packing | 1 | 11.95kg | 13.1kg | 0.070 | 560x1090x115 |
| | | | Visual (X-Y) | External (WxHxD) | |
| Product | | 480x660 | | 564x1052x524 | |
| 10.127 | | | Graphic Size: 650x700mm | | |

MONTANCHEZ H1000

* W: Width H: Height D: Depth *mm

| | QTY | N.W | G.W | C.B.M | Size (WxHxD) |
|---------------|-----|---------|--------------------------|------------------|--------------|
| Packing | 1 | 17.25kg | 19.3kg | 0.121 | 880x1375x100 |
| | | | Visual (X-Y) | External (WxHxD) | |
| Product | | 680x960 | | 764x1402x525 | |
| 10.128 | | | Graphic Size: 960x1000mm | | |

MONTANCHEZ H1400

* W: Width H: Height D: Depth *mm

| | QTY | N.W | G.W | C.B.M | Size (WxHxD) |
|---------------|-----|----------|---------------------------|------------------|--------------|
| Packing | 1 | 25.5kg | 28.5kg | 0.1886 | 1100x1805x98 |
| | | | Visual (X-Y) | External (WxHxD) | |
| Product | | 980x1360 | | 1064x1802x566 | |
| 10.129 | | | Graphic Size: 1360x1400mm | | |





PORTABLE LED LAMP



with rechargeable battery



INFORMATION

* W: Width H: Height D: Depth * mm

The Portable and rechargeable 1.8W LED Lamp is a very useful accessory for any display, has an autonomy of more than 6 hours and three levels of brightness (featuring a charging indicator display). With a stunning black finish, this portable LED Lamp will add a touch of distinction and functionality to your display. Thanks to its low consumption and its high strength clamp (3-4cm maximum grip) it can be coupled to a wide range of display products, among them Frame Boards, Blackboards, Photocalls, Lecterns or Counters.

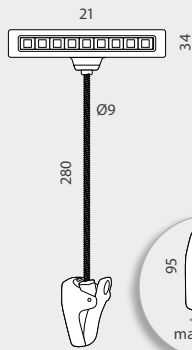

PORTABLE SPOTLIGHT

* W: Width H: Height D: Depth

*mm

| | QTY | N.W | G.W | C.B.M | Size (WxHxD) |
|---------|-----|--------|--------|---------|--------------|
| Packing | 1 | 0.30kg | 0.40kg | 0.00174 | 110x227x70 |

✿ 13.642



13.641
WOODEN FAST LECTERN
LECTERNS
Chapter 4



10.996
STEEL DISPLAY
POSTER DISPLAY
Chapter 1



14.111
A-BOARD SPECIAL TOP
BLACKBOARDS
Chapter 7

INFORMATION

* W: Width H: Height D: Depth * mm

The Dijon aluminum A-board is designed for outdoor use so it's perfect for advertising sales and promotions outside inside your store. It has a 32mm width profile with click system, so the graphic change is quick and simple. Thanks to its double-sided frame and its high this A-Board is ideal for advertising offers, menus, information maps, etc. It includes a weather resistant antireflection sheet so is also non-glare which allows it to be read under bright lights.

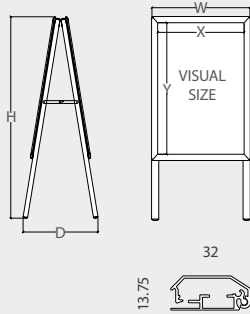

DIJON



double sided

DIJON H700

* W: Width H: Height D: Depth *mm

| | QTY | N.W | G.W | C.B.M | Size (WxHxD) | |
|---------|---------|--------------|------------------|--------|--------------|---|
| Packing | 1 | 5kg | 6.5kg | 0.0877 | 580x1120x135 |  |
| | | Visual (X-Y) | External (WxHxD) | | | |
| Product | 478x678 | | 542x1038x414 | | | |

✿ 10.558

Graphic Size: 500x700mm

DIJON A1

* W: Width H: Height D: Depth *mm

| | QTY | N.W | G.W | C.B.M | Size (WxHxD) | |
|---------|---------|--------------|------------------|--------|--------------|---|
| Packing | 1 | 6.4kg | 8.5kg | 0.0984 | 660x1420x105 |  |
| | | Visual (X-Y) | External (WxHxD) | | | |
| Product | 572x819 | | 636x1382x536 | | | |

✿ 10.557

Graphic Size: A1

DIJON H1000

* W: Width H: Height D: Depth *mm

| | QTY | N.W | G.W | C.B.M | Size (WxHxD) | |
|---------|---------|--------------|------------------|--------|--------------|---|
| Packing | 1 | 7.9kg | 9.65kg | 0.1562 | 790x1465x135 |  |
| | | Visual (X-Y) | External (WxHxD) | | | |
| Product | 678x978 | | 742x1382x536 | | | |

✿ 10.559

Graphic Size: 700x1000mm

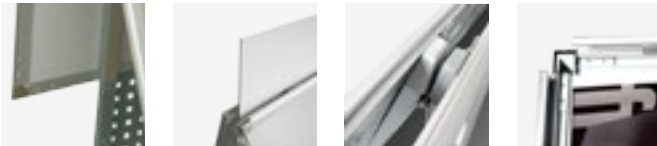

INFORMATION

* W: Width H: Height D: Depth * mm

This double-sided board is made of aluminum so it is lightweight and resistant to rusting. It has a 21mm width profile with click system, so the graphic change is quick and simple. Features a headboard support for displaying company logos or graphs. Ideal for outside or inside your store, restaurant, street stall or supermarket. It includes a weather resistant antireflection sheet so is also non-glare which allows it to be read under bright lights.

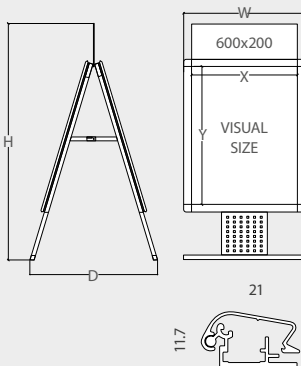

BELMEZ

- EN Headboard for graphic included.
- FR Support supérieur pour visuel inclus.
- PT Inclui suporte para cartaz superior.
- ES Con soporte para cartel superior.



double sided

BELMEZ

* W: Width H: Height D: Depth *mm

| | QTY | N.W | G.W | C.B.M | Size (WxHxD) | |
|---------|---------|--------------|------------------|--------|--------------|--|
| Packing | 1 | 13.9kg | 15.7kg | 0.1085 | 690x1210x130 | |
| | | Visual (X-Y) | External (WxHxD) | | | |
| Product | 581x828 | | 647x1160x625 | | | |

✿ 10.235

Graphic Size: A1

TOULOUSE



* W: Width H: Height D: Depth * mm

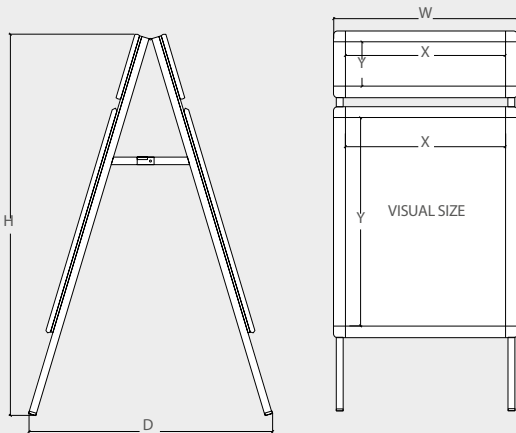
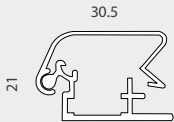

with upper head frame



quick graphic change

INFORMATION

This double sided A-board frame is made of aluminum so it is lightweight and resistant. It has a 30.5mm width profile with click system, so the graphic change is quick and simple. Also it includes a resistant antireflection sheet so is also non-glare which allows it to be read under bright lights. Features a headboard support for displaying company logos or graphs. Ideal for displaying sales or promotions at restaurants, stores, shops or supermarkets.

| TOULOUSE | | * W: Width | H: Height | D: Depth | *mm |
|----------|---|-----------------------------|--------------------------------|---|----------------------------|
| Packing | QTY: 1 | N.W: 9kg | G.W: 11kg | C.B.M: 0.1010 | Size (WxHxD): 610x120x1380 |
| Product | Board Visual (X-Y): 485x685 | Upper Visual (X-Y): 485x185 | External (WxHxD): 545x1210x630 |  | |
| * 10.806 | Board Graphic Size: 500x700mm Upper Graphic Size: 500x200mm | | | | |

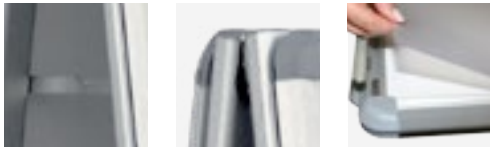

POZNAN



double sided



INFORMATION

* W: Width H: Height D: Depth * mm

The Poznan A-board frame is made of aluminum so it is lightweight and resistant to rusting. It has a 32mm width profile with click system, so the graphic change is quick and simple. Thanks its double-sided frame and its 1800mm height this A-Board is ideal for advertising large offers, menus, information maps, etc, outside or inside your business. It includes a weather resistant antireflection sheet so is also non-glare which allows it to be read under bright lights.

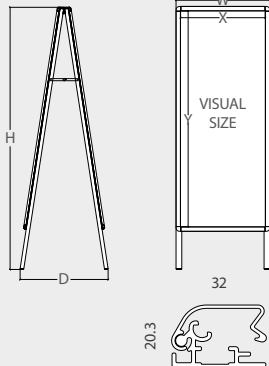

32mm

POZNAN

* W: Width H: Height D: Depth *mm

| | QTY | N.W | G.W | C.B.M | Size (WxHxD) |  |
|---------|----------|--------------|------------------|-------|--------------|---|
| Packing | 1 | 12.9kg | 14.8kg | 0.177 | 705x1860x135 | |
| | | Visual (X-Y) | External (WxHxD) | | | |
| Product | 581x1481 | | 644x1800x600 | | | |

☼ 10.343

Graphic Size: 600x1500mm

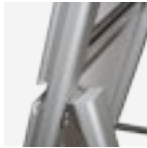

MOTA



suitable for indoor or outdoor use



25mm

quick and simple change of graphic



INFORMATION

* W: Width H: Height D: Depth * mm

This aluminium A-Board is very lightweight, foldable for an easy storage and very resistant to rusting. It features a 25mm width profile with click system, so the graphics change is quick and very simple. Also it includes a weather resistant antireflection sheet so is also non-glare which allows it to be read under bright lights. The Mota A-Board features 4 Click A3 frames so it is ideal for advertising sales or special promotions inside or outside your business. It's perfect for restaurants, stalls, stores or for any marketplace.

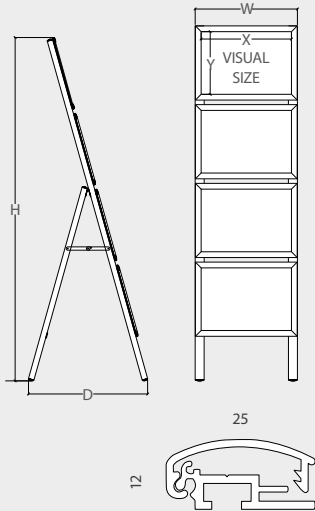

MOTA

* W: Width H: Height D: Depth *mm

| | QTY | N.W | G.W | C.B.M | Size (WxHxD) |
|---------|---------|--------------|---------------------|--------|--------------|
| Packing | 1 | 5.7kg | 7kg | 0.0902 | 500x1640x110 |
| | | Visual (X-Y) | External (WxHxD) | | |
| Product | 278x401 | | 450x1530x490 | | |
| 10.216 | | | Graphic Size: A3 x4 | | |

ALMENDRALEJO

- EN 3 options available: 6xA6 holders or 4xA5 holders or 3xA4 holders.
- FR 3 configurations de porte brochure à choisir : 6xA6, 4xA5 ou 3xA4.
- PT 3 opções de porta folhetos à escolha: 6xA6, 4xA5, 3xA4
- ES 3 configuraciones: 6 cajetines A6 o 4 cajetines A5 o 3 cajetines A4.



INFORMATION

* W: Width H: Height D: Depth * mm

The Almendralejo mobile board is designed to be used with brochure advertising. It has a 32mm width profile with click system, so the graphic change is quick and simple and it takes only a few minutes. Also it includes a resistant antireflection sheet and brake wheels, so it is very simple and comfortable to move. This mobile board is ideal for tradeshows, exhibitions, clinics, academies, highly-populated lobbies, travel agencies, libraries or waiting rooms to provide reading material to visiting clients.

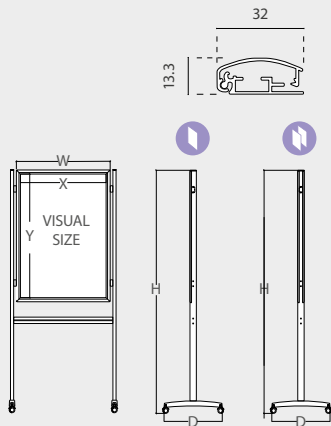

BROCHURE HOLDERS OPTIONS

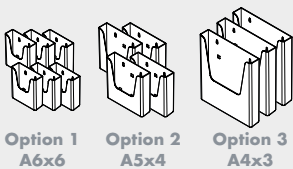

You can choose between 3 options to set-up your brochure holders:

- 6 Brochure Holders A6 size format.
- 4 Brochure Holders A5 size format.
- 3 Brochure Holders A4 size format.

ALMENDRALEJO

* W: Width H: Height D: Depth *mm

| | QTY | N.W | G.W | C.B.M | Size (WxHxD) |
|---------|---------|--------------|------------------|--------|--------------|
| Packing | 1 | 8.6kg | 10.9kg | 0.1258 | 860x1950x75 |
| | | Visual (X-Y) | External (WxHxD) | | |
| Product | 677x977 | | 834x1920x460 | | |

✱ 10.160 Graphic Size: 700x1000mm

ALMENDRALEJO 2-SIDED

* W: Width H: Height D: Depth *mm

| | QTY | N.W | G.W | C.B.M | Size (WxHxD) |
|---------|---------|--------------|------------------|--------|--------------|
| Packing | 1 | 10.3kg | 13.5kg | 0.1258 | 860x1950x75 |
| | | Visual (X-Y) | External (WxHxD) | | |
| Product | 677x977 | | 834x1920x460 | | |

✱ 10.759 Graphic Size: 700x1000mm



3 brochure holders configurations

brake wheels



32mm

click system profile

IBAHERNANDO



suitable for outdoor use



double sided



32mm

revolving board

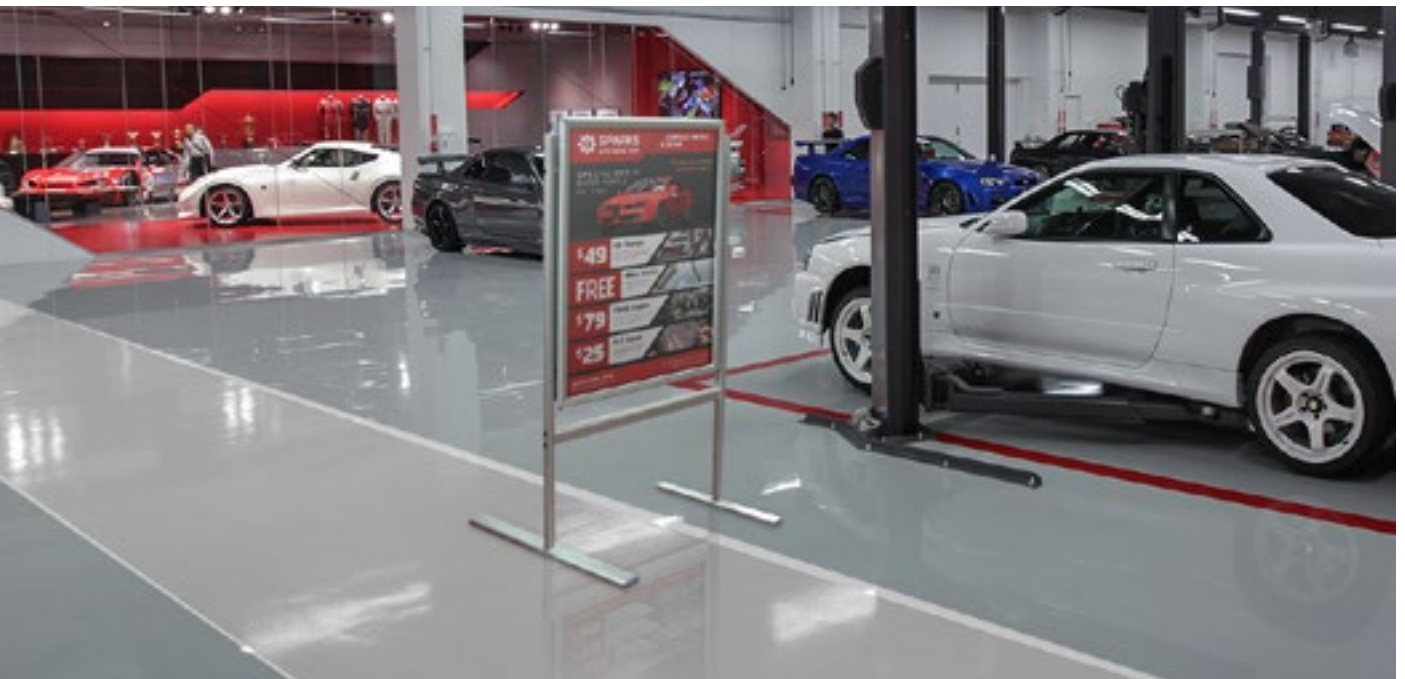

INFORMATION

This double-sided board is made of aluminum so it is lightweight and resistant thanks its strong feet. It has a 32mm width profile with click system, so the graphic change is quick and simple. Features a revolving board and it includes a resistant antireflection sheet so is also non-glare which allows it to be read under bright lights. Ideal for using outside your restaurant, street stall or supermarket for advertising offers, promotions or sales.

IBAHERNANDO

* W: Width H: Height D: Depth *mm

| | QTY | N.W | G.W | C.B.M | Size (WxHxD) |
|---------|-----|--------------|------------------|-------|--------------|
| Packing | 1 | 9.6kg | 11.8kg | 0.141 | 875x1535x105 |
| | | Visual (X-Y) | External (WxHxD) | | |
| Product | | 686x986 | 821x1506x847 | | |

10.165

Graphic Size: 700x1000mm



* W: Width H: Height D: Depth * mm

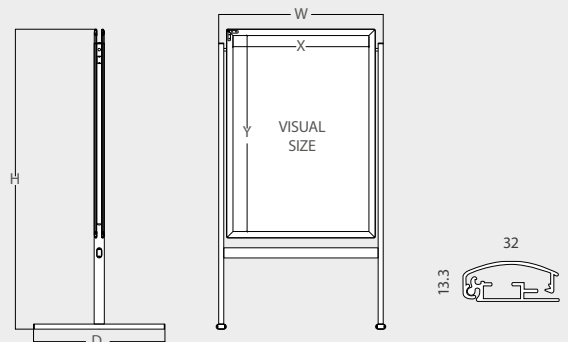



BOAL

double sided



suitable for outdoor use





INFORMATION

* W: Width H: Height D: Depth * mm

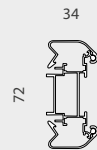
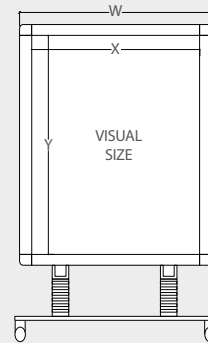
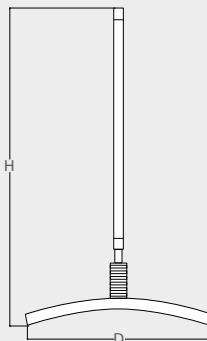
The double-sided board frame of Boal is made of aluminum and has a strong base and sturdy springboard design, allowing flexion in windy conditions. It has a 34mm width profile with click system, so the graphic change is quick and simple. Features a 2-sided board frame and it includes a resistant antireflection sheet so is also non-glare which allows it to be read under bright lights. Bad weather deters foot traffic for most venues, but these sidewalk signs will give you the advantage of letting passersby know you're open-regardless of the weather conditions. Ideal for displaying outside your event, restaurant, street stall or supermarket for advertising offers or temporary exhibitions.



| BOAL | | * W: Width | | H: Height | D: Depth | *mm |
|--|---------|-------------------------|------------------|-----------|--------------|--|
| | QTY | N.W | G.W | C.B.M | Size (WxHxD) | |
| Packing | 1 | 7.8kg | 9.4kg | 0.066 | 750x1100x80 |  x2 |
| | 1 | 4.55kg | 4.85kg | 0.009 | 140x670x100 | |
| | | Visual (X-Y) | External (WxHxD) | | |  |
| Product | 570x815 | 640x1130x560 | | | | |
|  10.166 | | Graphic Size: 605x860mm | | | | |

suitable for outdoor use



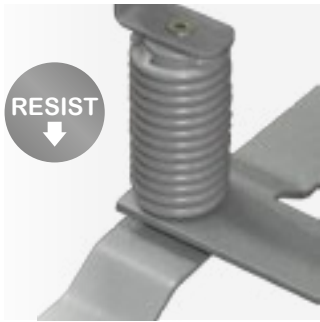

HERVAS



double sided
suitable for outdoor use



INFORMATION

* W: Width H: Height D: Depth * mm

The double-sided board Hervas is made of aluminum and has a strong base with a wide footprint and sturdy springboard design, allowing flexion in windy conditions. It has a 42mm width profile with click system, so the graphic change is quick and simple. Features a 2-sided board frame and it includes a resistant antireflection sheet so is also non-glare which allows it to be read under bright lights. Bad weather deters foot traffic for most venues, but these sidewalk signs will give you the advantage of letting passersby know you're open-regardless of the weather conditions. Ideal for using outside your gas station, restaurant, street stall or supermarket for advertising offers or temporary promotions.

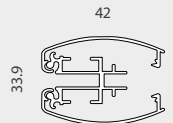
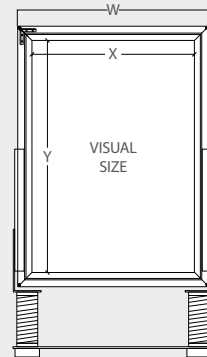
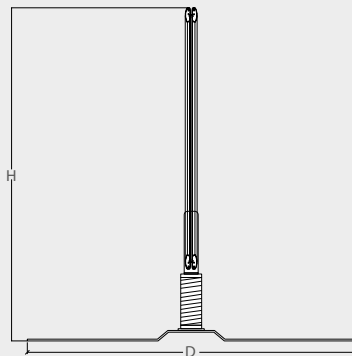

| HERVAS H700 | | * W: Width | | H: Height | D: Depth | *mm |
|---|---------|-------------------------|------------------|-----------|--------------|---|
| Packing | QTY | N.W | G.W | C.B.M | Size (WxHxD) |  |
| | 1 | 4.2kg | 5.05kg | 0.0373 | 965x595x65 | |
| Product | 1 | 9.35kg | 9.5kg | 0.0043 | 1010x77x55 |  |
| | | Visual (X-Y) | External (WxHxD) | | | |
| | 466x666 | 575x956x940 | | | | |
|  | 10.161 | Graphic Size: 500x700mm | | | | |

| HERVAS H1000 | | * W: Width | | H: Height | D: Depth | *mm |
|---|---------|--------------------------|------------------|-----------|--------------|---|
| Packing | QTY | N.W | G.W | C.B.M | Size (WxHxD) |  |
| | 1 | 6.75kg | 8.45kg | 0.0574 | 785x1125x65 | |
| Product | 1 | 9.35kg | 9.5kg | 0.0043 | 1010x77x55 |  |
| | | Visual (X-Y) | External (WxHxD) | | | |
| | 666x966 | 750x1256x940 | | | | |
|  | 10.162 | Graphic Size: 700x1000mm | | | | |



ARCACHON



42mm

24 L

Capacity
Ref. 10.341
Ref. 10.115



double sided

52 L

Capacity
Ref. 10.342
Ref. 10.116



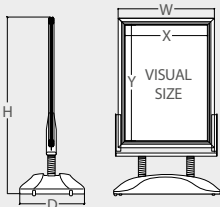

INFORMATION

*mm



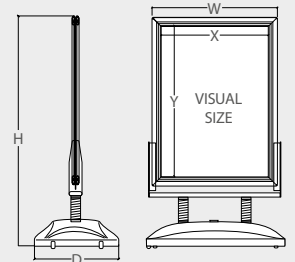

The Arcachon Board is a great way to draw attention from the street. This Click Board is designed especially for outdoor use, it is made from durable materials for a stable and long-lasting construction. The heavy-duty, molded plastic base features a screw-in cap and can be filled with 24l of water for 10.341 and 10.115 models and 52l for 10.116 and 10.342. Also it has a 42mm width waterproof profile with click system, so the graphic change is quick and simple. It includes a weather resistant antireflection sheet so is also non-glare which allows it to be read under bright lights. Built-in wheels also make this board easy to move as needed. To further enhance its stability Arcachon features rugged springs to reduce the impact of wind. With all these characteristics this waterproof Click Board is ideal for displaying outside your restaurant, street stall, event or supermarket for advertising offers or any temporary exhibition.



| ARCACHON H500 | | * W: Width | H: Height | D: Depth | *mm |
|---------------|--------------|-------------------------|------------------|----------|---|
| Packing | QTY | N.W | G.W | C.B.M | Size (WxHxD) |
| | 1 Frame | 6.75kg | 8.1kg | 0.0475 | 660x900x80 |
| Product | 1 Base | 3.7kg | 4.4kg | 0.068 | 800x170x500 |
| | Visual (X-Y) | | External (WxHxD) | | 24L   |
| * 10.115 | | Graphic Size: 500x700mm | | | |

| ARCACHON H700 | | * W: Width | H: Height | D: Depth | *mm |
|---------------|--------------|--------------------------|------------------|----------|---|
| Packing | QTY | N.W | G.W | C.B.M | Size (WxHxD) |
| | 1 Frame | 9.1kg | 10.5kg | 0.0745 | 810x1150x80 |
| Product | 1 Base | 5.75kg | 6.5kg | 0.1085 | 970x610x180 |
| | Visual (X-Y) | | External (WxHxD) | | 52L   |
| * 10.116 | | Graphic Size: 700x1000mm | | | |

| ARCACHON A1 | | * W: Width | H: Height | D: Depth | *mm |
|-------------|--------------|------------------|------------------|----------|---|
| Packing | QTY | N.W | G.W | C.B.M | Size (WxHxD) |
| | 1 Frame | 8.1kg | 9.2kg | 0.0616 | 740x1040x90 |
| Product | 1 Base | 3.7kg | 4.4kg | 0.068 | 800x170x500 |
| | Visual (X-Y) | | External (WxHxD) | | 24L   |
| * 10.341 | | Graphic Size: A1 | | | |

| ARCACHON A0 | | * W: Width | H: Height | D: Depth | *mm |
|-------------|--------------|------------------|------------------|----------|---|
| Packing | QTY | N.W | G.W | C.B.M | Size (WxHxD) |
| | 1 Frame | 10.25kg | 11.60kg | 0.1051 | 980x1340x80 |
| Product | 1 Base | 5.75kg | 6.5kg | 0.1085 | 970x610x180 |
| | Visual (X-Y) | | External (WxHxD) | | 52L   |
| * 10.342 | | Graphic Size: A0 | | | |



MIKONOS



double sided



double sided



17 L Capacity
Ref. 15.243



*Printing on fabric.
Impression sur toile.
Impressão em tecido.
Impresión en tela.

17 L Capacity
Ref. 15.242

EXTERNAL SIZES & DOWNLOADABLES ARTWORKS (QR CODE)

*mm

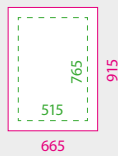
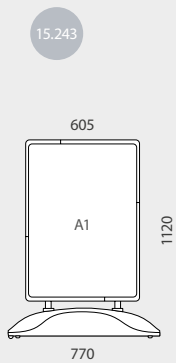

SAFE ZONE
TOTAL GRAPHIC



Mikonos features a lightweight aluminum structure with a refillable plastic base that assembles in seconds (It is 3.95kg weight and it can be filled with 17l of water). Also, the Textile Boards are also simple to setup. All the aluminium poles fit together and snap into base. Simply stretch the wrap over the completed base and it's ready to use. The aluminium structure is affixed to the base with 2 large springs, so it stays stable in windy conditions. Built-in wheels also make this board easy to move as needed. Carrying bag is included for an easy storage and transportation. Denote your business with the innovative design and versatility of textile printing. Ideal for trade shows or promotional events. The Mikonos outdoor board is ideal for being used at heavily-trafficked areas such as tradeshow, events, stores or malls.

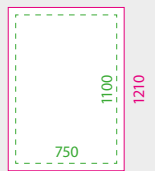
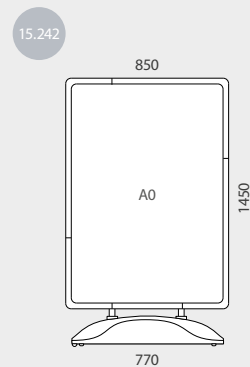

SAFE ZONE
TOTAL GRAPHIC



* Custom textil printing in full color is available but not included.

| MIKONOS A1 | | | | | | *mm |
|-----------------|-----|-------|-------|-------|------------------------|-------------|
| | QTY | N.W | G.W | C.B.M | Size (WxHxD) | |
| Packing | 1 | 7.5kg | 9.5kg | 0.11 | 520x940x230 | 17 L |
| * 15.243 | | | | | Graphic Size:665x915mm | |

| MIKONOS A0 | | | | | | *mm |
|-----------------|-----|-----|------|-------|-------------------------|-------------|
| | QTY | N.W | G.W | C.B.M | Size (WxHxD) | |
| Packing | 1 | 8kg | 10kg | 0.11 | 520x940x230 | 17 L |
| * 15.242 | | | | | Graphic Size:860x1210mm | |



CLICK DISPLAYS

| | |
|----|---|
| EN | Click Frame Display with one or more frames. Aluminium profiles. Single or double-sided. For Indoor or outdoor use. |
| FR | Profils en aluminium, permettant l'affichage d'un ou plusieurs cadres. Simple/double face. utilisation intérieure ou extérieure. |
| PT | Expositores com um ou mais marcos. Disponível em uma face ou em dupla face. Perfis de alumínio. Pode ser usado no interior ou exterior. |
| ES | Columna gráfica con uno o más marcos. Perfiles de aluminio. Disponible a una o dos caras. Apto para exterior o interior. |

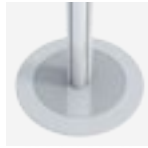

GUADALUPE A4

INFORMATION

* W: Width H: Height D: Depth * mm

Sign displays can be used in a variety of indoor locations to showcase eye-catching graphics and signage. These sign displays are equipped with click frames which let you display horizontal and vertical A4 graphics. If you choose the configuration of single-sided, you can display 4x A4-sized graphics. Also you can create a double-sided presentation by attaching your sign holders back to back and exposing 8x A4-sized graphics. Guadalupe features a 8kg weight base made of steel. These sign displays are made of aluminum and feature a smooth silver finish.

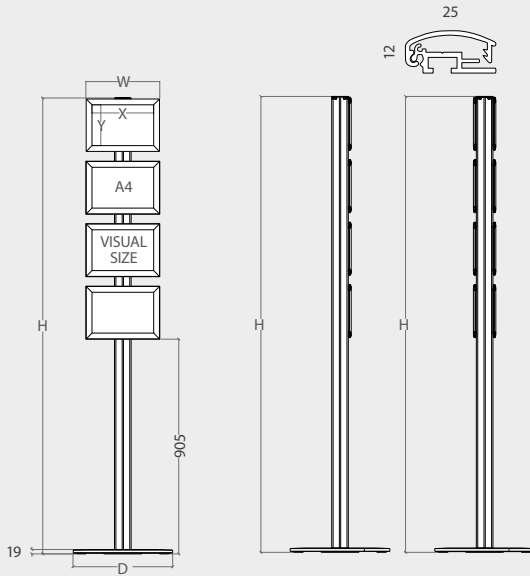

size A4:
4 or 8
frames



25mm

aluminium
profile

single or
double
sided



steel base
8 kg

GUADALUPE A4 SINGLE

* W: Width H: Height D: Depth *mm

| | QTY | N.W | G.W | C.B.M | Size (WxHxD) | |
|---------|--------------|----------------|------------------|--------|--------------|----|
| Packing | 1 | 2.8kg | 3.6kg | 0.0123 | 80x1920x80 | x6 |
| | 1 | 8.2kg | 8.5kg | 0.0097 | 440x440x50 | |
| | 4 | 0.45kg | 0.55kg | 0.0024 | 270x350x25 | |
| Product | Visual (X-Y) | | External (WxHxD) | | | |
| | 190x278 | 311x1922x Ø420 | | | | |

10.154 Graphic Size: A4 x 4uni.

GUADALUPE A4 DOUBLE

* W: Width H: Height D: Depth *mm

| | QTY | N.W | G.W | C.B.M | Size (WxHxD) | |
|---------|--------------|----------------|------------------|--------|--------------|-----|
| Packing | 1 | 2.8kg | 3.6kg | 0.0123 | 80x1920x80 | x10 |
| | 1 | 8.2kg | 8.5kg | 0.0097 | 440x440x50 | |
| | 8 | 0.45kg | 0.55kg | 0.0024 | 270x350x25 | |
| Product | Visual (X-Y) | | External (WxHxD) | | | |
| | 190x278 | 311x1922x Ø420 | | | | |

10.156 Graphic Size: A4 x 8uni.

GUADALUPE A3



INFORMATION

* W: Width H: Height D: Depth * mm

Sign displays can be used in a variety of indoor locations to showcase eye-catching graphics and signage. These sign displays are equipped with click frames which let you display horizontal and vertical A3 graphics. If you choose the configuration of single-sided, you can display 3x A3-sized graphics. Also you can create a double-sided presentation by attaching your sign holders back to back and exposing 6x A3-sized graphics. Guadalupe features a 8kg weight base are made of steel. These sign displays are made of aluminum and feature a smooth silver finish.

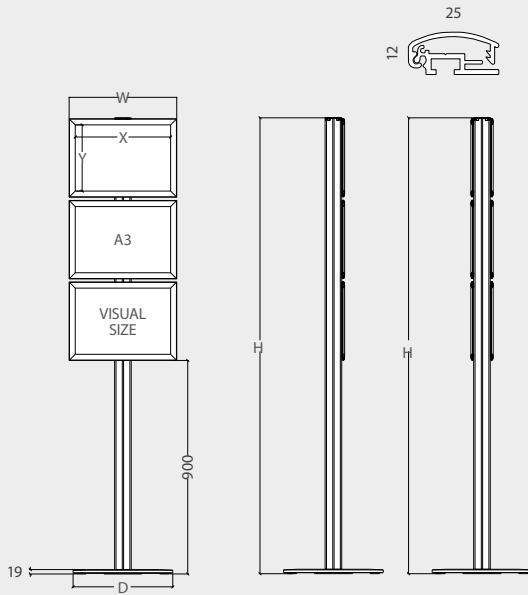

quick and simple graphic change

size A3:
3 or 6
frames



25mm

aluminium profile



single or double sided

steel base 8 kg

| GUADALUPE A3 SINGLE | | | | | | * W: Width | H: Height | D: Depth | *mm |
|---------------------|--------------------------|--------|------------------|------------|--------------|------------|-----------|----------|-----|
| Packing | QTY | N.W | G.W | C.B.M | Size (WxHxD) | | | | |
| | 1 | 2.8kg | 3.6kg | 0.0123 | 80x1920x80 | | | | x5 |
| | 1 | 8.2kg | 8.5kg | 0.0097 | 440x440x50 | | | | |
| 3 | 0.65kg | 0.85kg | 0.0061 | 365x480x35 | | | | | |
| | Visual (X-Y) | | External (WxHxD) | | | | | | |
| Product | 278x401 | | 453x1922x Ø420 | | | | | | |
| 10.155 | Graphic Size: A3 x 3uni. | | | | | | | | |

| GUADALUPE A3 DOUBLE | | | | | | * W: Width | H: Height | D: Depth | *mm |
|---------------------|--------------------------|--------|------------------|------------|--------------|------------|-----------|----------|-----|
| Packing | QTY | N.W | G.W | C.B.M | Size (WxHxD) | | | | |
| | 1 | 2.8kg | 3.6kg | 0.0123 | 80x1920x80 | | | | x8 |
| | 1 | 8.2kg | 8.5kg | 0.0097 | 440x440x50 | | | | |
| 6 | 0.65kg | 0.85kg | 0.0061 | 365x480x35 | | | | | |
| | Visual (X-Y) | | External (WxHxD) | | | | | | |
| Product | 278x401 | | 453x1922x Ø420 | | | | | | |
| 10.157 | Graphic Size: A3 x 6uni. | | | | | | | | |



PLASENCIA

INFORMATION

* W: Width H: Height D: Depth * mm

Sign displays can be used in a variety of indoor locations to showcase eye-catching graphics and signage. These sign displays are equipped with click frames. Simply flip open the frames' molding and slide your graphics behind the non-glare lenses. These sign displays are made of aluminum and feature a smooth silver finish. Also double-sided presentation is available.

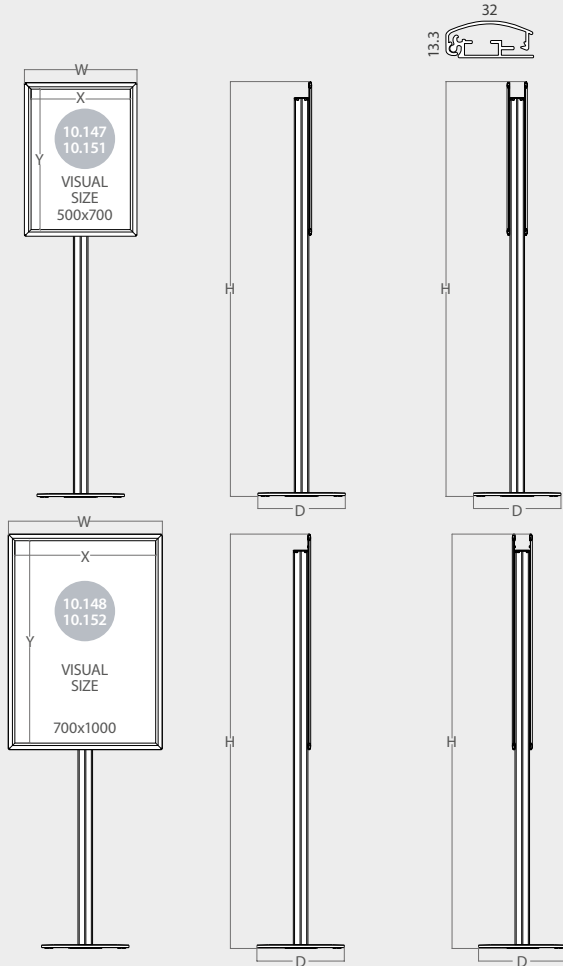

highly resistant!

single or double sided





32mm

aluminium profile

steel base 8 kg





PLASENCIA H700 * W: Width H: Height D: Depth *mm

| | QTY | N.W | G.W | C.B.M | Size (WxHxD) | |
|---------|--------------|-------|------------------|--------|--------------|--|
| Packing | 1 | 2.8kg | 3.6kg | 0.0123 | 80x1920x80 |  x3 |
| | 1 | 8.2kg | 8.5kg | 0.0097 | 440x440x50 | |
| | 1 | 1.5kg | 2kg | 0.0104 | 560x745x25 | |
| | Visual (X-Y) | | External (WxHxD) | | |  |
| Product | 478x678 | | 540x1922x Ø420 | | |  |



 10.147 Graphic Size: 500x700 x 1uni.

PLASENCIA H1000 * W: Width H: Height D: Depth *mm

| | QTY | N.W | G.W | C.B.M | Size (WxHxD) | |
|---------|--------------|--------|------------------|--------|--------------|--|
| Packing | 1 | 2.8kg | 3.6kg | 0.0123 | 80x1920x80 |  x3 |
| | 1 | 8.2kg | 8.5kg | 0.0097 | 440x440x50 | |
| | 1 | 2.55kg | 3.25kg | 0.0123 | 80x1920x80 | |
| | Visual (X-Y) | | External (WxHxD) | | |  |
| Product | 678x978 | | 740x1922x Ø420 | | |  |



 10.148 Graphic Size: 700x1000 x 1uni.

PLASENCIA H700 DOUBLE * W: Width H: Height D: Depth *mm

| | QTY | N.W | G.W | C.B.M | Size (WxHxD) | |
|---------|--------------|-------|------------------|--------|--------------|--|
| Packing | 1 | 2.8kg | 3.6kg | 0.0123 | 80x1920x80 |  x4 |
| | 1 | 8.2kg | 8.5kg | 0.0097 | 440x440x50 | |
| | 2 | 1.5kg | 2kg | 0.0104 | 560x745x25 | |
| | Visual (X-Y) | | External (WxHxD) | | |  |
| Product | 478x678 | | 540x1922x Ø420 | | |  |

 10.151 Graphic Size: 500x700 x 2uni.

PLASENCIA H1000 DOUBLE * W: Width H: Height D: Depth *mm

| | QTY | N.W | G.W | C.B.M | Size (WxHxD) | |
|---------|--------------|--------|------------------|--------|--------------|--|
| Packing | 1 | 2.8kg | 3.6kg | 0.0123 | 80x1920x80 |  x4 |
| | 1 | 8.2kg | 8.5kg | 0.0097 | 440x440x50 | |
| | 2 | 2.55kg | 3.25kg | 0.0123 | 80x1920x80 | |
| | Visual (X-Y) | | External (WxHxD) | | |  |
| Product | 678x978 | | 740x1922x Ø420 | | |  |

 10.152 Graphic Size: 700x1000 x 2uni.

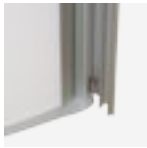
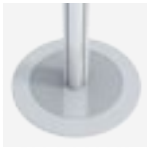

INFORMATION

* W: Width H: Height D: Depth * mm

The Leinster double-sided display is built from sturdy, durable aluminum frame. With an easy-to-use snap frame and edge-lit LED bulbs, Leinster lightbox stand is useful for darker venues, such as halls and movie theaters. The convex holder helps graphics pop out, ensuring that the double sided poster display can be seen from any angle. Designed for day or night time use, the illuminated lightbox stand has clear PVC lens to prevent glare, while the LED bulbs highlight signage.

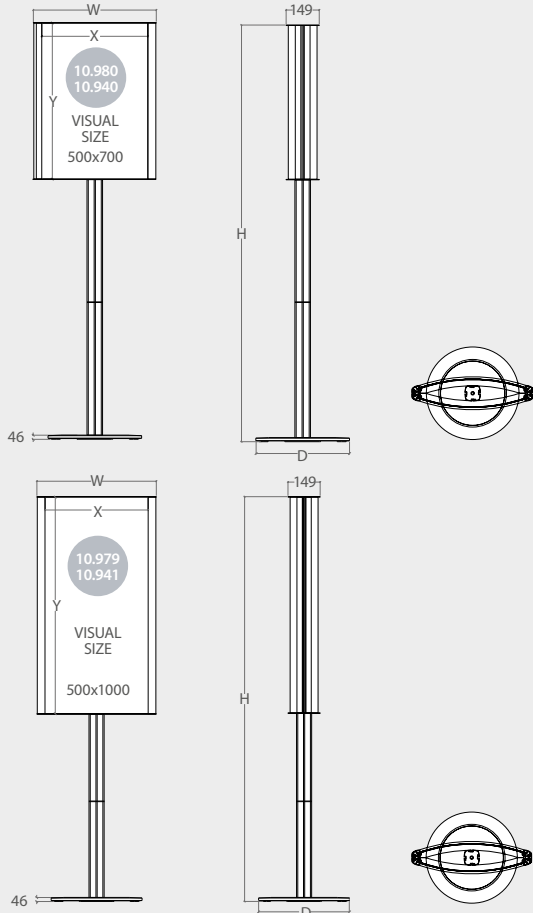

LEINSTER H700

* W: Width H: Height D: Depth *mm

| | QTY | N.W | G.W | C.B.M | Size (WxHxD) | |
|---------|--------------|---------|------------------|--------|--------------|--|
| Packing | 1 | 18.75kg | 21.3kg | 0.1202 | 1095x610x180 | |
| | 1 | 8.2kg | 8.5kg | 0.009 | 440x440x50 | |
| | Visual (X-Y) | | External (WxHxD) | | | |
| Product | 476x700 | | 552x1868x Ø420 | | | |

*10.980

Graphic Size: 500x700

LEINSTER H1000

* W: Width H: Height D: Depth *mm

| | QTY | N.W | G.W | C.B.M | Size (WxHxD) | |
|---------|--------------|---------|------------------|--------|--------------|--|
| Packing | 1 | 18.75kg | 21.3kg | 0.1202 | 1095x610x180 | |
| | 1 | 8.20kg | 8.5kg | 0.009 | 440x440x50 | |
| | Visual (X-Y) | | External (WxHxD) | | | |
| Product | 476x1000 | | 552x1868x Ø420 | | | |

*10.979

Graphic Size: 500x1000

LEINSTER



available with or without LED



highly resistant!



single or double sided

steel base 8 kg

LEINSTER H700 LED

* W: Width H: Height D: Depth *mm

| | QTY | N.W | G.W | C.B.M | Size (WxHxD) | |
|---------|--------------|---------|------------------|--------|--------------|--|
| Packing | 1 | 18.75kg | 21.3kg | 0.1202 | 1095x610x180 | |
| | 1 | 8.2kg | 8.5kg | 0.009 | 440x440x50 | |
| | Visual (X-Y) | | External (WxHxD) | | | |
| Product | 476x700 | | 552x1868x Ø420 | | | |

*10.940

Graphic Size: 500x700

LEINSTER H1000 LED

* W: Width H: Height D: Depth *mm

| | QTY | N.W | G.W | C.B.M | Size (WxHxD) | |
|---------|--------------|---------|------------------|--------|--------------|--|
| Packing | 1 | 18.75kg | 21.3kg | 0.1202 | 1095x610x180 | |
| | 1 | 8.20kg | 8.5kg | 0.009 | 440x440x50 | |
| | Visual (X-Y) | | External (WxHxD) | | | |
| Product | 476x1000 | | 552x1868x Ø420 | | | |

*10.941

Graphic Size: 500x1000



LIGHT BOXES

| | |
|----|--|
| EN | LED light box. Using "click" profile system and anodized aluminium. AC power supply and anti-reflex cover included. |
| FR | Cadre lumineux à LED. Système click. Profil en aluminium anodisé. Alimentation AC et protection antireflet inclus. |
| PT | Marco luminoso Led. Perfil com sistema "click" em alumínio anodizado. Transformador e película antirreflexo incluídos. |
| ES | Marcos luminosos a pared con sistema de apertura "click". Fabricado en aluminio. Incluye anti-reflex y alimentación eléctrica. |



YUCATAN



INFORMATION

* W: Width H: Height D: Depth * mm

This window hanging light box for daily use combines the power of LED illumination technology with the elegance of a thin profile. The frame on each model is 17.8mm thick, making it one of the slimmest marketing devices currently available. Small LED bulbs in the sides of the window hanging light box frame prevents against "hot" and "cold" spots appearing on the graphics. The diffusion pattern within the lightbox makes sure that the beams shed evenly over the images. Users can also adorn this LED signage to the wall. The thin window hanging light box showcases posters and graphics in either landscape or portrait orientation.

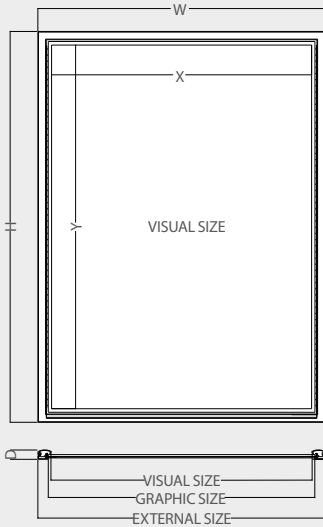

other sizes available upon request

YUCATAN

* W: Width H: Height D: Depth *mm

| Ref. | Graphic Size | Visual (X-Y) | External (WxHxD) | Profile | Packing (QTY) | N.W | G.W | C.B.M | Size (WxHxD) | | |
|--------|--------------|--------------|------------------|---------|---------------|--------|--------|-------------|--------------|--|--|
| 13.207 | A0 | 828x1176 | 880x1228x17.8 | | 1 | 7.25kg | 10.1kg | 0.0737 | 910x1350x60 | | |
| 13.208 | A1 | 581x828 | 633x880x17.8 | | 1 | 3.95kg | 5.5kg | 0.0398 | 660x1005x60 | | |
| 13.209 | A2 | 407x581 | 459x633x17.8 | | 1 | 2.1kg | 3.1kg | 0.0222 | 490x755x60 | | |
| 13.210 | A3 | 284x407 | 336x459x17.8 | | 1 | 1.3kg | 1.95kg | 0.0128 | 365x585x60 | | |
| 13.211 | A4 | 197x284 | 249x336x17.8 | | 1 | 0.8kg | 1.2kg | 0.0077 | 280x460x60 | | |
| 13.295 | 500x700 | 487x686 | 539x738x17.8 | | 1 | 2.85kg | 4.1kg | 0.0296 | 570x865x60 | | |
| 13.296 | 700x1000 | 687x987 | 739x1039x17.8 | 1 | 5.3kg | 7.3kg | 0.0538 | 770x1165x60 | | | |

* Other sizes available upon request / Autres dimension sur demande / Outros tamanhos disponíveis sob consulta / Otros tamaños disponibles bajo pedido.



ARTEGA



32mm profile thickness

INFORMATION

* W: Width H: Height D: Depth * mm

Artega hanging light box for daily use combines the power of LED illumination technology with silver finish of aluminium. Small LED bulbs in the sides of the 19.75mm thickness frame prevents against "hot" and "cold" spots appearing on the graphics. The diffusion pattern within the lightbox makes sure that the beams shed evenly over the images. Users can also adorn this LED signage to the wall. The Artega hanging light box showcases posters and graphics in either landscape or portrait orientation.

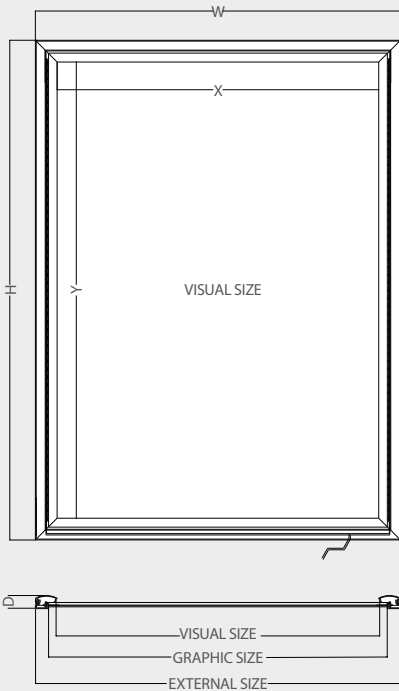

silver anodized aluminium finish

AC power supply included

| ARTEGA | | | | * W: Width H: Height D: Depth *mm | | | | | | | |
|--------|--------------|--------------|------------------|-----------------------------------|---------------|--------|--------|-------------|--------------|--|--|
| Ref. | Graphic Size | Visual (X-Y) | External (WxHxD) | Profile | Packing (QTY) | N.W | G.W | C.B.M | Size (WxHxD) | | |
| 13.202 | A0 | 815x1163 | 880x1228x19.75 | | 1 | 7.25kg | 10.1kg | 0.0737 | 910x1350x60 | | |
| 13.203 | A1 | 568x815 | 633x880x19.75 | | 1 | 3.95kg | 5.5kg | 0.0398 | 660x1005x60 | | |
| 13.204 | A2 | 394x568 | 459x633x19.75 | | 1 | 2.1kg | 3.1kg | 0.0222 | 490x755x60 | | |
| 13.205 | A3 | 271x394 | 336x459x19.75 | | 1 | 1.3kg | 1.95kg | 0.0128 | 365x585x60 | | |
| 13.206 | A4 | 184x271 | 249x336x19.75 | | 1 | 0.8kg | 1.2kg | 0.0077 | 280x460x60 | | |
| 13.293 | 500x700 | 474x673 | 539x738x19.75 | | 1 | 2.85kg | 4.1kg | 0.0296 | 570x865x60 | | |
| 13.294 | 700x1000 | 674x974 | 739x1039x19.75 | 1 | 5.3kg | 7.3kg | 0.0538 | 770x1165x60 | | | |

* Other sizes available upon request / Autres dimension sur demande / Outros tamanhos disponíveis sob consulta / Otros tamaños disponibles bajo pedido.



CAMPECHE



"click"
profile system

INFORMATION

* W: Width H: Height D: Depth * mm

The Campeche frame display is built from sturdy, durable aluminum frame. With an easy-to-use snap frame and edge-lit LED bulbs, Campeche lightbox stand is useful for darker venues, such as halls and movie theaters. The convex holder helps graphics pop out, ensuring that the double sided poster display can be seen from any angle. Designed for day or night time use, the illuminated lightbox stand has clear PVC lens to prevent glare, while the LED bulbs highlight signage.

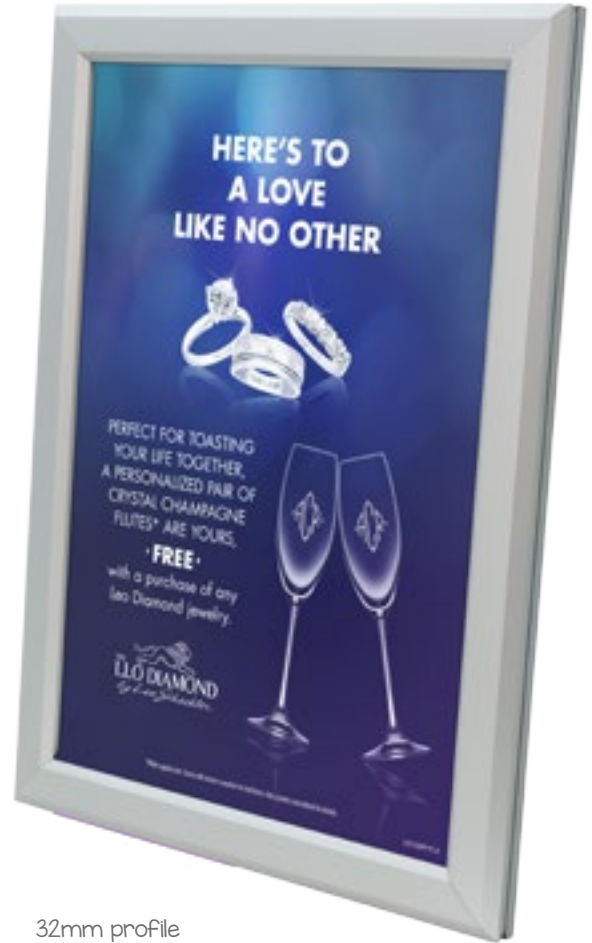
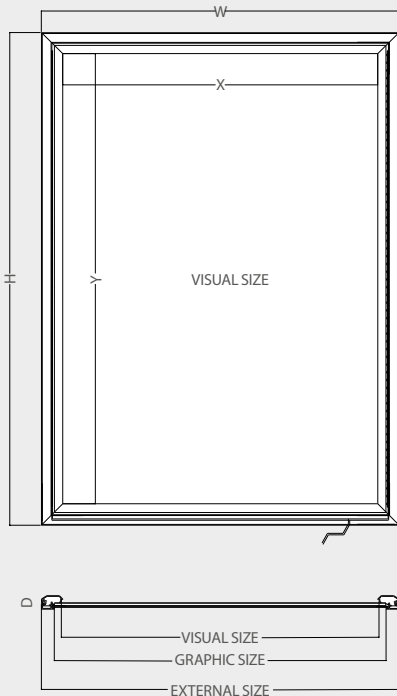

32mm profile
thickness

other sizes available
upon request

CAMPECHE

* W: Width H: Height D: Depth *mm

| Ref. | Graphic Size | Visual (X-Y) | External (WxHxD) | Profile | Packing (QTY) | N.W | G.W | C.B.M | Size (WxHxD) | | |
|--------|--------------|--------------|------------------|---------|---------------|--------|--------|--------|--------------|--|--|
| 13.217 | A0 | 815x1163 | 880x1228x20.15 | | 1 | 7.25kg | 10.1kg | 0.0737 | 910x1350x60 | | |
| 13.218 | A1 | 568x815 | 633x880x20.15 | | 1 | 3.95kg | 5.5kg | 0.0398 | 660x1005x60 | | |
| 13.219 | A2 | 394x568 | 459x633x20.15 | | 1 | 2.1kg | 3.1kg | 0.0222 | 490x755x60 | | |
| 13.220 | A3 | 271x394 | 336x459x20.15 | | 1 | 1.3kg | 1.95kg | 0.0128 | 365x585x60 | | |
| 13.221 | A4 | 184x271 | 249x336x20.15 | | 1 | 0.8kg | 1.2kg | 0.0077 | 280x460x60 | | |
| 13.291 | 500x700 | 474x673 | 539x738x20.15 | | 1 | 2.85kg | 4.1kg | 0.0296 | 570x865x60 | | |
| 13.292 | 700x1000 | 674x974 | 739x1039x20.15 | | 1 | 5.3kg | 7.3kg | 0.0538 | 770x1165x60 | | |

* Other sizes available upon request / Autres dimension sur demande / Outros tamanhos disponíveis sob consulta / Otros tamaños disponibles bajo pedido.



NOGALES



INFORMATION

* W: Width H: Height D: Depth * mm

The Nogales double-sided frame is built from sturdy, durable aluminum frame. With an easy-to-use snap frame and edge-lit LED bulbs, Lainster lightbox stand is useful for darker venues, such as halls and movie theaters. The vertical holder tubes, ensuring that the double sided poster display can be seen from any angle. Designed for day or night time use, the illuminated lightbox stand has clear PVC lens to prevent glare, while the LED bulbs highlight signage.

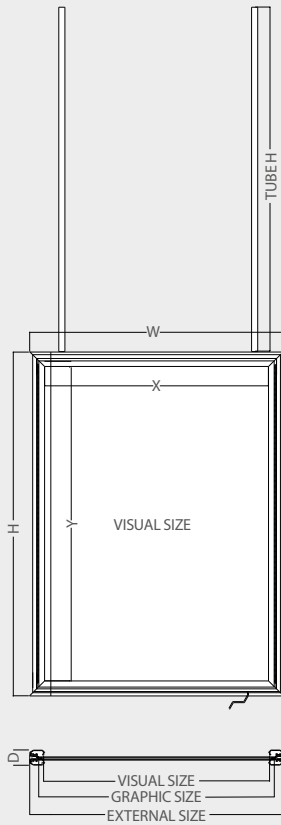



double sided



32mm profile thickness

silver anodized aluminum

double sided click system

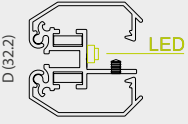
| NOGALES | | | | | * W: Width H: Height D: Depth *mm | | | |    | | | | |
|----------|--------------|--------------|------------------|--------|---|---------------|--------|--------|---|--------------|--|--|--|
| Ref. | Graphic Size | Visual (X-Y) | External (WxHxD) | Tube H | Profile | Packing (QTY) | N.W | G.W | C.B.M | Size (WxHxD) | | | |
| * 13.190 | A0 | 815x1163 | 880x1228x32.2 | 1228 |  | 1 | 10.8kg | 13.4kg | 0.1050 | 964x1379x79 | | | |
| * 13.191 | A1 | 568x815 | 633x880x32.2 | 880 | | 1 | 6.05kg | 7.85kg | 0.0584 | 717x1031x79 | | | |
| * 13.192 | A2 | 394x568 | 459x633x32.2 | 633 | | 1 | 3.5kg | 4.6kg | 0.0336 | 543x784x79 | | | |
| * 13.193 | A3 | 271x394 | 336x459x32.2 | 459 | | 1 | 2.15kg | 2.85kg | 0.0140 | 420x610x79 | | | |
| * 13.194 | A4 | 184x271 | 249x336x32.2 | 336 | | 1 | 1.35kg | 1.9kg | 0.0128 | 333x487x79 | | | |
| * 13.289 | 500x700 | 474x673 | 539x738x32.2 | 738 | | 1 | 4.55kg | 5.85kg | 0.0438 | 623x890x79 | | | |
| * 13.290 | 700x1000 | 674x974 | 739x1039x32.2 | 1039 | | 1 | 7.95kg | 9.95kg | 0.0727 | 790x1165x79 | | | |

* Other sizes available upon request / Autres dimension sur demande / Outros tamanhos disponíveis sob consulta / Otros tamaños disponibles bajo pedido.

SINTRA

- EN Available with and without light.
- FR Disponible avec ou sans éclairage.
- PT Disponível com ou sem iluminação.
- ES Disponible con y sin iluminación.



INFORMATION

* W: Width H: Height D: Depth * mm

The Sintra double-sided sign stand is built from sturdy, durable silver anodized aluminum. With an easy-to-use Click frame (edge-lit LED optional). This mobile frame features 4 rolling brake wheels, so it is very simple and comfortable to move. Designed for day or nighttime use, the illuminated lightbox stand has clear PVC lens to prevent glare. Sintra is the ideal display frame for advertising in retail locations, restaurants, clinics, academies or exhibitions, also if you choose the optional LED Light, Sintra double-sided lightbox stand is useful for darker halls or for movie theaters.

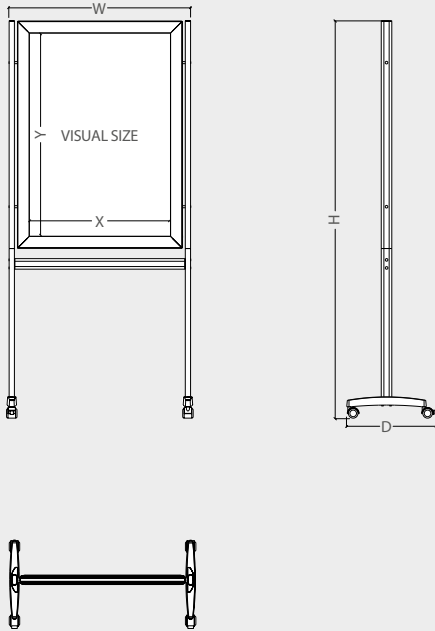

| SINTRA | | * W: Width | H: Height | D: Depth | * mm |
|---------------|--------------|--------------------------|-----------|----------|--------------|
| | QTY | N.W | G.W | C.B.M | Size (WxHxD) |
| Packing | 1 | 16.5kg | 19.95kg | 0.01455 | 920x140x130 |
| | Visual (X-Y) | External (WxHxD) | | | |
| Product | 683x983 | 900x1925x430 | | | |
| 10.313 | | Graphic Size: 700x1000mm | | | |

| SINTRA LED LIGHT | | * W: Width | H: Height | D: Depth | * mm |
|------------------|--------------|--------------------------|-----------|----------|--------------|
| | QTY | N.W | G.W | C.B.M | Size (WxHxD) |
| Packing | 1 | 20.35kg | 22.7kg | 0.01455 | 920x140x130 |
| | Visual (X-Y) | External (WxHxD) | | | |
| Product | 683x983 | 900x1925x430 | | | |
| 10.767 | | Graphic Size: 700x1000mm | | | |

| | |
|----|--|
| EN | Light box frame for graphics. With anti-reflex and steel base. Available in different sizes. |
| FR | Totem lumineux avec antireflet. Base en acier. Disponible en plusieurs tailles. |
| PT | Totém luminoso com película protetora e base em aço. Disponível em vários tamanhos. |
| ES | Totém luminoso con anti-reflex y base en acero. Disponible en diferentes medidas. |



GENOVA LIGHT WALL TOTEM

INFORMATION * W: Width H: Height D: Depth * mm

The Genova light wall poster holder totem consists of a high quality anodized aluminum poster frame along with an accompanying satin metal base. With an easy-to-use snap frame, this system allows an easy and quick poster change. The poster holder display, which is a curved sign holder also features backlit LED illumination. Designed for day or night time use, the illuminated lightbox stand has clear PVC lens to prevent glare. Genova is ideal for using at hospitals, clinics, academies or exhibitions, also thanks its LED Light, Genova lightbox stand is useful for darker halls or movie theaters.

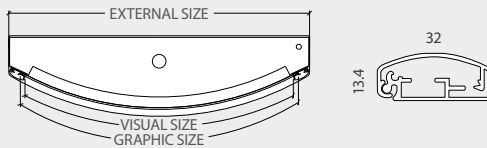
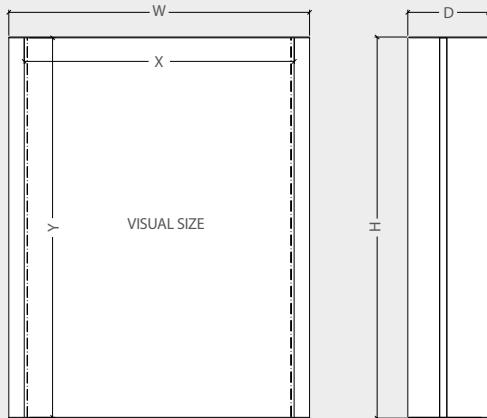

silver anodized aluminium

32mm

fast change of graphic



| GENOVA 700 LED | | * W: Width | H: Height | D: Depth | *mm |
|----------------|-------------------|-------------------------|-------------|---------------|---------------------------|
| Packing | QTY: 1 | N.W: 9.4kg | G.W: 10.9kg | C.B.M: 0.0918 | Size (WxHxD): 600x765x200 |
| | Visual (X-Y) | External (WxHxD) | | | |
| Product | 518x707 | 710x560x150 | | | |
| 10.117 | Visual: 500x700mm | Graphic Size: 539x707mm | | | |

| GENOVA 1000 LED | | * W: Width | H: Height | D: Depth | *mm |
|-----------------|--------------------|--------------------------|--------------|---------------|----------------------------|
| Packing | QTY: 1 | N.W: 15.05kg | G.W: 17.45kg | C.B.M: 0.1758 | Size (WxHxD): 805x1065x205 |
| | Visual (X-Y) | External (WxHxD) | | | |
| Product | 712x10007 | 760x1010x150 | | | |
| 10.348 | Visual: 700x1000mm | Graphic Size: 734x1007mm | | | |



OBIDOS



INFORMATION

* W: Width H: Height D: Depth * mm

The Obidos double-sided Totem is built from sturdy, durable silver anodized aluminum with a steel base. Designed for day or night time use, the illuminated lightbox stand has clear PVC lens to prevent glare. Also known as a Light Totem, Obidos is freestanding and is very well suited as display frame for advertising in restaurants, clinics, academies or exhibitions, also thanks its LED Light, it's useful for darker halls or movie theaters. With its unique convex display and bright illumination, Obidos is sure to attract the attention of your target audience.

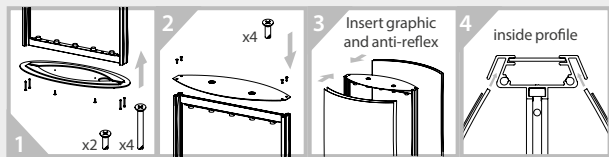
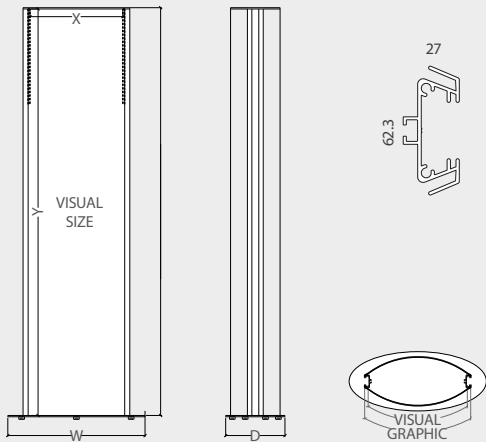

double sided



anti-reflective plastic included

OBIDOS H1600

* W: Width H: Height D: Depth *mm

| | QTY | N.W | G.W | C.B.M | Size (WxHxD) | |
|---------|-------------------|--------|--------------------------|--------|--------------|----|
| Packing | 1 | 9.46kg | 11.70kg | 0.1078 | 570x1645x115 | x2 |
| | 1 | 5.30kg | 5.65kg | 0.0054 | 565x275x35 | |
| Product | Visual (X-Y) | | External (WxHxD) | | | |
| | 488x1600 | | 540x1610x234 | | | |
| 10.221 | Totem: 500x1600mm | | Graphic Size: 516x1600mm | | | |

OBIDOS H1800

* W: Width H: Height D: Depth *mm

| | QTY | N.W | G.W | C.B.M | Size (WxHxD) | |
|---------|-------------------|---------|--------------------------|--------|--------------|----|
| Packing | 1 | 13.20kg | 16.10kg | 0.14 | 660x1845x115 | x2 |
| | 1 | 6.05kg | 6.45kg | 0.0072 | 665x310x35 | |
| Product | Visual (X-Y) | | External (WxHxD) | | | |
| | 602x1800 | | 640x1810x277 | | | |
| 10.222 | Totem: 600x1800mm | | Graphic Size: 630x1800mm | | | |

OBIDOS H2000

* W: Width H: Height D: Depth *mm

| | QTY | N.W | G.W | C.B.M | Size (WxHxD) | |
|---------|-------------------|------|--------------------------|--------|--------------|----|
| Packing | 1 | 16kg | 19.40kg | 0.1764 | 750x2045x115 | x2 |
| | 1 | 10kg | 10.50kg | 0.0095 | 765x355x35 | |
| Product | Visual (X-Y) | | External (WxHxD) | | | |
| | 703x2000 | | 740x2010x320 | | | |
| 10.223 | Totem: 700x2000mm | | Graphic Size: 731x2000mm | | | |



CASCAIS

anti-reflective plastic included

- EN Available with and without light.
- FR Disponible avec ou sans éclairage.
- PT Disponível com ou sem iluminação.
- ES Disponible con y sin iluminación.



INFORMATION

* W: Width H: Height D: Depth * mm

The Cascais double-sided Totem is built from sturdy, durable silver anodized aluminum with steel base. Designed for day or night time use, the illuminated lightbox stand has clear PVC lens to prevent glare. This Totem is freestanding and is very well suited as display frame for advertising in retail locations, restaurants, clinics, academies or exhibitions, also if you choose the optional LED Light, Cascais lightbox stand is useful for darker halls or movie theaters.

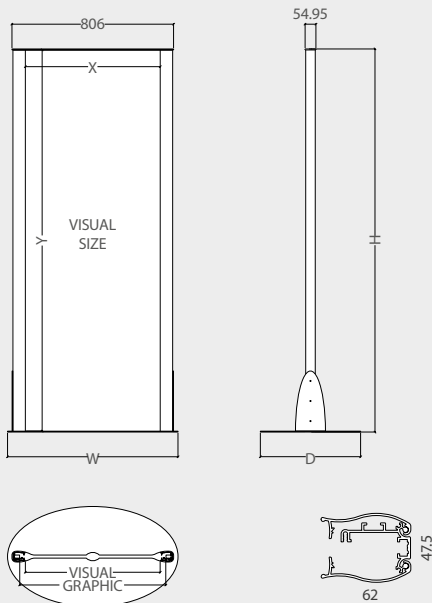

| CASCAIS | | * W: Width | | H: Height | D: Depth | *mm |
|---------|-------------------|------------------|--------------------------|-----------|--------------|-----|
| Packing | QTY | N.W | G.W | C.B.M | Size (WxHxD) | x2 |
| | 1 | 19.25kg | 21.9kg | 0.1579 | 850x1955x95 | |
| Product | Visual (X-Y) | External (WxHxD) | | | | |
| | 672x1900 | 850x1910x500 | | | | |
| 10.356 | Totem: 700x1900mm | | Graphic Size: 728x1900mm | | | |

| CASCAIS LED | | * W: Width | | H: Height | D: Depth | *mm |
|-------------|-------------------|------------------|--------------------------|-----------|--------------|-----|
| Packing | QTY | N.W | G.W | C.B.M | Size (WxHxD) | x2 |
| | 1 | 20.45kg | 23.1kg | 0.1579 | 850x1955x95 | |
| Product | Visual (X-Y) | External (WxHxD) | | | | |
| | 672x1900 | 850x1910x500 | | | | |
| 10.354 | Totem: 700x1900mm | | Graphic Size: 728x1900mm | | | |

- EN Available with and without light.
- FR Disponible avec ou sans éclairage.
- PT Disponível com ou sem iluminação.
- ES Disponible con y sin iluminación.



INFORMATION

* W: Width H: Height D: Depth * mm

The Nantes double-sided Totem is built from sturdy, durable silver anodized aluminum with steel base. Designed for day or night time use, the illuminated lightbox stand has clear PVC lens to prevent glare. Also known as a Light Totem, Nantes is freestanding and is very well suited as display frame for advertising in restaurants, clinics, academies or exhibitions, also thanks its LED Light, it's useful for darker halls or movie theaters. With its unique convex display and bright illumination, Nantes is sure to attract the attention of your target audience.

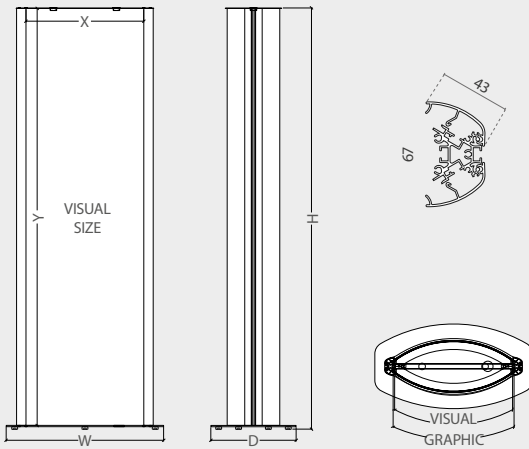

NANTES



anti-reflective plastic



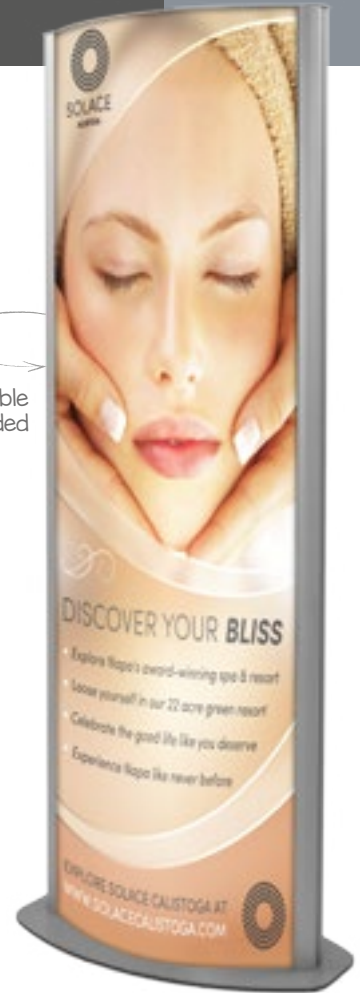

double sided





NANTES H1200 * W: Width H: Height D: Depth *mm

| | QTY | N.W | G.W | C.B.M | Size (WxHxD) | |
|---------------|-------------------|--------------|--------------------------|--------|--------------|--|
| Packing | 1 | 8.25kg | 10.1kg | 0.0816 | 570x1245x115 |  x2 |
| | 1 | 7.65kg | 8.65kg | 0.0077 | 620x355x35 | |
| | | Visual (X-Y) | External (WxHxD) | | |  |
| Product | 485x1200 | | 600x1217x325 | | | |
| 10.602 | Totem: 500x1200mm | | Graphic Size: 524x1200mm | | | |



NANTES H1600 * W: Width H: Height D: Depth *mm

| | QTY | N.W | G.W | C.B.M | Size (WxHxD) | |
|---------------|-------------------|--------------|--------------------------|--------|--------------|--|
| Packing | 1 | 9.5kg | 11.45kg | 0.1078 | 570x1645x115 |  x2 |
| | 1 | 7.65kg | 8.65kg | 0.0077 | 620x355x35 | |
| | | Visual (X-Y) | External (WxHxD) | | |  |
| Product | 485x1600 | | 600x1617x325 | | | |
| 10.436 | Totem: 500x1600mm | | Graphic Size: 524x1600mm | | | |



NANTES H1800 * W: Width H: Height D: Depth *mm

| | QTY | N.W | G.W | C.B.M | Size (WxHxD) | |
|---------------|-------------------|--------------|--------------------------|--------|--------------|--|
| Packing | 1 | 14.6kg | 17kg | 0.14 | 660x1845x115 |  x2 |
| | 1 | 9.95kg | 11.05kg | 0.0101 | 720x400x35 | |
| | | Visual (X-Y) | External (WxHxD) | | |  |
| Product | 588x1800 | | 700x1817x370 | | | |
| 10.460 | Totem: 600x1800mm | | Graphic Size: 626x1800mm | | | |



NANTES W700xH1800 * W: Width H: Height D: Depth *mm

| | QTY | N.W | G.W | C.B.M | Size (WxHxD) | |
|---------------|-------------------|--------------|--------------------------|--------|--------------|--|
| Packing | 1 | 15.95kg | 18.55kg | 0.1570 | 740x1845x115 |  x2 |
| | 1 | 13.4kg | 14.55kg | 0.0132 | 820x460x35 | |
| | | Visual (X-Y) | External (WxHxD) | | |  |
| Product | 695x1800 | | 800x1817x427 | | | |
| 10.521 | Totem: 700x1800mm | | Graphic Size: 724x1800mm | | | |



NANTES H1200 LED * W: Width H: Height D: Depth *mm

| | QTY | N.W | G.W | C.B.M | Size (WxHxD) | |
|---------------|-------------------|--------------|--------------------------|--------|--------------|---|
| Packing | 1 | 9.35kg | 11.2kg | 0.0816 | 570x1245x115 |  x2 |
| | 1 | 7.65kg | 8.65kg | 0.0077 | 620x355x35 | |
| | | Visual (X-Y) | External (WxHxD) | | |   |
| Product | 485x1200 | | 600x1217x325 | | | |
| 10.402 | Totem: 500x1200mm | | Graphic Size: 524x1200mm | | | |



NANTES H1600 LED * W: Width H: Height D: Depth *mm

| | QTY | N.W | G.W | C.B.M | Size (WxHxD) | |
|---------------|-------------------|--------------|--------------------------|--------|--------------|---|
| Packing | 1 | 10.5kg | 12.45kg | 0.1078 | 570x1645x115 |  x2 |
| | 1 | 7.65kg | 8.65kg | 0.0077 | 620x355x35 | |
| | | Visual (X-Y) | External (WxHxD) | | |   |
| Product | 485x1600 | | 600x1617x325 | | | |
| 10.464 | Totem: 500x1600mm | | Graphic Size: 524x1600mm | | | |

NANTES 1800 LED * W: Width H: Height D: Depth *mm

| | QTY | N.W | G.W | C.B.M | Size (WxHxD) | |
|---------------|-------------------|--------------|--------------------------|--------|--------------|---|
| Packing | 1 | 15.6kg | 18kg | 0.14 | 660x1845x115 |  x2 |
| | 1 | 9.95kg | 11.05kg | 0.0101 | 720x400x35 | |
| | | Visual (X-Y) | External (WxHxD) | | |   |
| Product | 588x1800 | | 700x1817x370 | | | |
| 10.465 | Totem: 600x1800mm | | Graphic Size: 626x1800mm | | | |

NANTES W700xH1800 LED * W: Width H: Height D: Depth *mm

| | QTY | N.W | G.W | C.B.M | Size (WxHxD) | |
|---------------|-------------------|--------------|--------------------------|--------|--------------|---|
| Packing | 1 | 16.95kg | 19.55kg | 0.1570 | 740x1845x115 |  x2 |
| | 1 | 13.4kg | 14.55kg | 0.0132 | 820x460x35 | |
| | | Visual (X-Y) | External (WxHxD) | | |   |
| Product | 695x1800 | | 800x1817x427 | | | |
| 10.556 | Totem: 700x1800mm | | Graphic Size: 724x1800mm | | | |



INFORMATION

* W: Width H: Height D: Depth * mm

This Ulster Menu Stand is made of aluminium and features an anti-reflex protection cover for its A3 frame. The Ulster frame borders snap open which allows to insert quickly and easily your printed graphics. Also, it features the option of customize with an inside graphic. It is ideal for hotel lobbies, for restaurant entrances, car dealerships or real states.

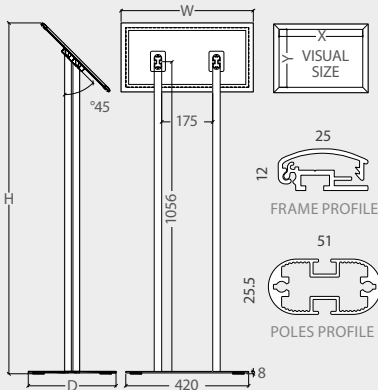

ULSTER * W: Width H: Height D: Depth *mm

| | QTY | N.W | G.W | C.B.M | Size (WxHxD) | |
|---------|---------|--------------|------------------|--------|--------------|----|
| Packing | 1 | 2.15kg | 2.5kg | 0.0102 | 145x1170x60 | x3 |
| | 1 | 5kg | 5.3kg | 0.0061 | 365x480x35 | |
| | 1 | 0.65kg | 0.85kg | 0.0061 | 365x480x35 | |
| | | Visual (X-Y) | External (WxHxD) | | | |
| Product | 400x277 | 452x1200x300 | | | | |

* 10.982 Graphic Size: A3

ULSTER



25mm

INFORMATION

* W: Width H: Height D: Depth * mm

This Menu Stand features a sturdy aluminium structure with plastic parts. Its Click System frame allows an easy and quick graphic change (anti-reflex cover included). Frames features portrait or a landscape configuration. It is ideal for retail stores, hotel lobbies, restaurant entrances, car dealerships and real states.

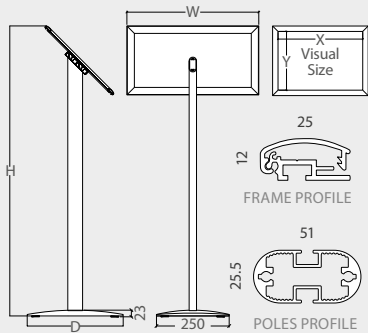

ZAFRA A3 * W: Width H: Height D: Depth *mm

| | QTY | N.W | G.W | C.B.M | Size (WxHxD) | |
|---------|---------|--------------|------------------|--------|--------------|----|
| Packing | 1 | 0.75kg | 0.95kg | 0.0047 | 60x930x85 | x3 |
| | 1 | 1.65kg | 1.76kg | 0.0034 | 275x355x35 | |
| | 1 | 0.65kg | 0.85kg | 0.0061 | 365x480x35 | |
| | | Visual (X-Y) | External (WxHxD) | | | |
| Product | 400x277 | 453x998x330 | | | | |

* 10.159 Graphic Size: A3

ZAFRA A4 * W: Width H: Height D: Depth *mm

| | QTY | N.W | G.W | C.B.M | Size (WxHxD) | |
|---------|---------|--------------|------------------|--------|--------------|----|
| Packing | 1 | 0.75kg | 0.95kg | 0.0047 | 60x930x85 | x3 |
| | 1 | 1.65kg | 1.76kg | 0.0034 | 275x355x35 | |
| | 1 | 0.45kg | 0.55kg | 0.0024 | 270x350x25 | |
| | | Visual (X-Y) | External (WxHxD) | | | |
| Product | 190x278 | 311x960x330 | | | | |

* 10.158 Graphic Size: A4

ZAFRA

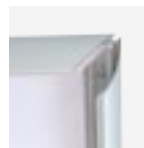

25mm



available in A3 and A4 sizes



MELGAR ONE-SIDED



INFORMATION

* W: Width H: Height D: Depth * mm

This Menu Stand features a sturdy aluminium structure with plastic parts. Its Click System frame allows an easy and quick graphic change (anti-reflex cover included). Frames features portrait or a landscape configuration. Also Melgar is available with an A4 leaflet dispenser. It is ideal for retail stores, hotel lobbies, restaurant entrances, car dealerships and real states. Melgar is sure to attract the attention of your target audience.

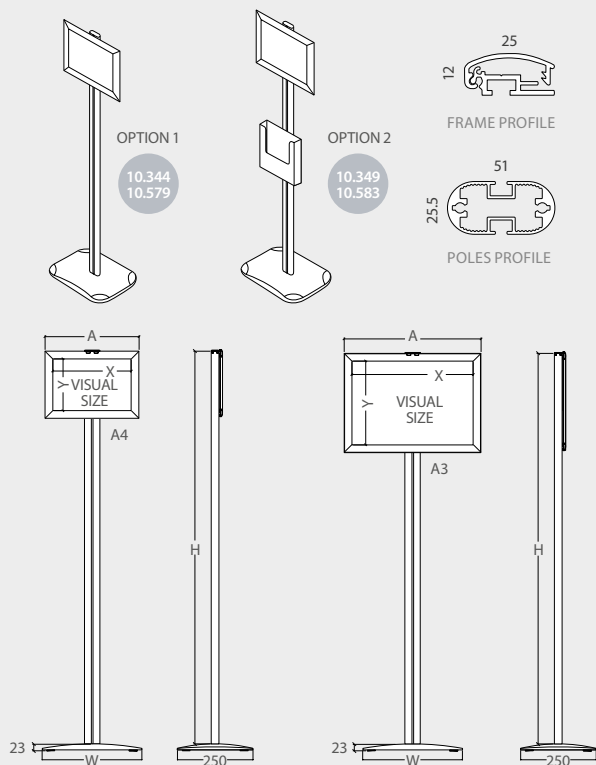



easy format change

click system

25mm

| MELGAR A4 1SIDED | | * W: Width | H: Height | D: Depth | *mm | |
|------------------|--------------|------------------|-----------|---|--------------|--|
| Packing | QTY | N.W | G.W | C.B.M | Size (WxHxD) |  x3 |
| | 1 | 1.15kg | 1.25kg | 0.0035 | 65x1340x40 | |
| | 1 | 2.8kg | 2.93kg | 0.0036 | 263x388x35 | |
| | 1 | 0.82kg | 0.91kg | 0.0024 | 350x270x25 | |
| Product | Visual (X-Y) | External (WxHxA) | |  | | |
| *10.344 | | Graphic Size: A4 | | | | |

| MELGAR A3 1SIDED | | * W: Width | H: Height | D: Depth | *mm | |
|------------------|--------------|------------------|-----------|---|--------------|--|
| Packing | QTY | N.W | G.W | C.B.M | Size (WxHxD) |  x3 |
| | 1 | 1.15kg | 1.25kg | 0.0035 | 65x1340x40 | |
| | 1 | 2.8kg | 2.93kg | 0.0032 | 263x388x35 | |
| | 1 | 1.44kg | 1.74kg | 0.0042 | 475x355x25 | |
| Product | Visual (X-Y) | External (WxHxA) | |  | | |
| *10.579 | | Graphic Size: A3 | | | | |

| MELGAR A4 1S+DISPENSER | | * W: Width | H: Height | D: Depth | *mm | |
|------------------------|--------------|------------------|-----------|--|--------------|--|
| Packing | QTY | N.W | G.W | C.B.M | Size (WxHxD) |  x4 |
| | 1 | 1.15kg | 1.25kg | 0.0035 | 65x1340x40 | |
| | 1 | 2.8kg | 2.93kg | 0.0036 | 263x388x35 | |
| | 1 | 0.4kg | 0.55kg | 0.0029 | 235x250x50 | |
| | 1 | 0.82kg | 0.91kg | 0.0024 | 350x270x25 | |
| Product | Visual (X-Y) | External (WxHxA) | |  | | |
| *10.349 | | Graphic Size: A4 | | with A4  x1 | | |

| MELGAR A3 1S+DISPENSER | | * W: Width | H: Height | D: Depth | *mm | |
|------------------------|--------------|------------------|-----------|--|--------------|--|
| Packing | QTY | N.W | G.W | C.B.M | Size (WxHxD) |  x4 |
| | 1 | 1.15kg | 1.25kg | 0.0035 | 65x1340x40 | |
| | 1 | 2.8kg | 2.93kg | 0.0036 | 263x388x35 | |
| | 1 | 0.4kg | 0.55kg | 0.0029 | 235x250x50 | |
| | 1 | 1.44kg | 1.74kg | 0.0042 | 475x355x25 | |
| Product | Visual (X-Y) | External (WxHxA) | |  | | |
| *10.583 | | Graphic Size: A3 | | with A4  x1 | | |

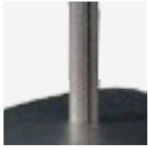

MELGAR TWO-SIDED



INFORMATION

* W: Width H: Height D: Depth * mm

This Menu Stand features a sturdy aluminium structure with plastic parts. Its Click System frame allows an easy and quick graphic change (anti-reflex cover included). Frames features portrait or a landscape configuration. Also Melgar is available with an A4 leaflet dispenser. It is ideal for retail stores, hotel lobbies, restaurant entrances, car dealerships and real states. Melgar is sure to attract the attention of your target audience.

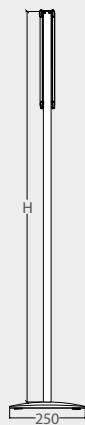
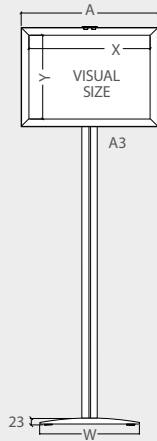
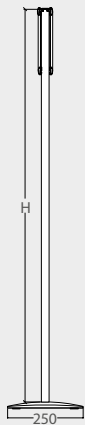
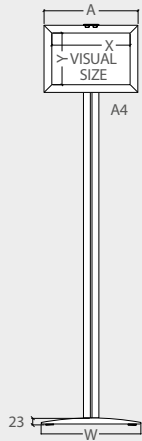
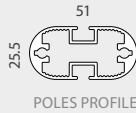
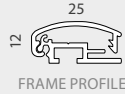
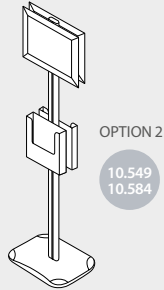
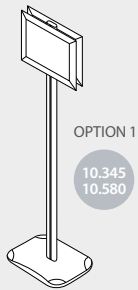

aluminium profiles

25mm



MELGAR A4 2SIDED

* W: Width H: Height D: Depth *mm

| | QTY | N.W | G.W | C.B.M | Size (WxHxD) | |
|---------|--------------|------------------|--------|--------|--------------|--|
| Packing | 1 | 1.15kg | 1.25kg | 0.0035 | 65x1340x40 |  x4 |
| | 1 | 2.8kg | 2.93kg | 0.0036 | 263x388x35 | |
| | 2 | 0.82kg | 0.91kg | 0.0024 | 350x270x25 | |
| | Visual (X-Y) | External (WxHxA) | | | | |
| Product | 190x278 | 330x1326x329 | | | | |

*10.345

Graphic Size: A4

MELGAR A3 2SIDED

* W: Width H: Height D: Depth *mm



| | QTY | N.W | G.W | C.B.M | Size (WxHxD) | |
|---------|--------------|------------------|--------|--------|--------------|--|
| Packing | 1 | 1.15kg | 1.25kg | 0.0035 | 65x1340x40 |  x4 |
| | 1 | 2.8kg | 2.93kg | 0.0036 | 263x388x35 | |
| | 2 | 1.44kg | 1.74kg | 0.0042 | 475x355x25 | |
| | Visual (X-Y) | External (WxHxA) | | | | |
| Product | 278x401 | 330x1326x453 | | | | |

*10.580

Graphic Size: A3

MELGAR A4 2S+2 DISPENSERS

* W: Width H: Height D: Depth *mm

| | QTY | N.W | G.W | C.B.M | Size (WxHxD) | |
|---------|--------------|------------------|--------|--------|--------------|--|
| Packing | 1 | 1.15kg | 1.25kg | 0.0035 | 65x1340x40 |  x6 |
| | 1 | 2.8kg | 2.93kg | 0.0036 | 263x388x35 | |
| | 2 | 0.4kg | 0.55kg | 0.0029 | 235x250x50 | |
| | 2 | 0.82kg | 0.91kg | 0.0024 | 350x270x25 | |
| | Visual (X-Y) | External (WxHxA) | | | | |
| Product | 190x278 | 330x1326x311 | | | |  |



*10.549

Graphic Size: A4

with A4  x2

MELGAR A3 2S+2 DISPENSERS

* W: Width H: Height D: Depth *mm

| | QTY | N.W | G.W | C.B.M | Size (WxHxD) | |
|---------|--------------|------------------|--------|--------|--------------|--|
| Packing | 1 | 1.15kg | 1.25kg | 0.0035 | 65x1340x40 |  x6 |
| | 1 | 2.8kg | 2.93kg | 0.0036 | 263x388x35 | |
| | 2 | 0.4kg | 0.55kg | 0.0029 | 235x250x50 | |
| | 2 | 1.44kg | 1.74kg | 0.0042 | 475x355x25 | |
| | Visual (X-Y) | External (WxHxA) | | | | |
| Product | 278x401 | 330x1326x453 | | | |  |

*10.584

Graphic Size: A3

with A4  x2

supplied in complete kits

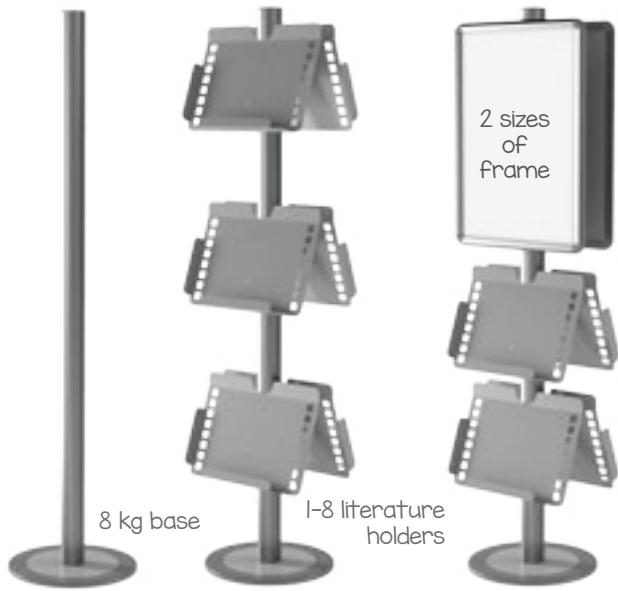

COMBI

- EN Full set of holders of easy assembly. The displays "Combi" are supplied in complete Kits. Made of aluminum and steel.
- FR Support porte brochures en aluminium et métal. Assemblage facile, plusieurs configurations sont possibles.
- PT Sistema completo de porta-folhetos e/ou marcos. Os display fornecem-se em kits completos. Fabricados em alumínio e aço.
- ES Sistema completo de portafolletos y/o portagráficas. Los displays se suministran en Kits completos y están realizados en aluminio y acero.

INFORMATION

* W: Width H: Height D: Depth * mm

The Combi Display system consists of an aluminium pole profile, a solid 8kg base and multiple possible configurations to choose from, featuring the number of literature holders trays (1-8 units), the possibility of incorporating one or more click system frames (different sizes available) or the possibility of adding a double-sided design. Each of the 4 literature trays can hold either 2 units of A4 sized brochures or 1 extra wide magazine. The Combi Displays are ideal for trade shows, lobby areas, hotel lobbies, shopping malls or for the gymnasiums.

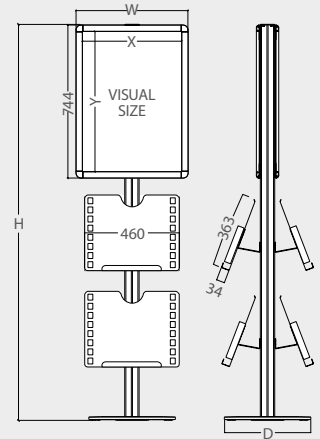

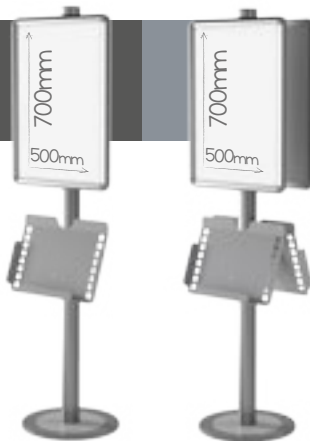

COMBI ONE



COMBI ONE 1SIDED

* W: Width H: Height D: Depth *mm



| | QTY | N.W | G.W | C.B.M | Size (WxHxD) | |
|---------|--------------|--------|------------------|--------|--------------|--|
| Packing | 1 | 2.8kg | 3.6kg | 0.0123 | 80x1920x80 |  x4 |
| | 1 | 8.2kg | 8.5kg | 0.0097 | 440x440x50 | |
| | 1 | 1.95kg | 2.2kg | 0.0089 | 380x470x50 | |
| | 1 | 1.95kg | 2.4kg | 0.0104 | 560x745x25 | |
| | Visual (X-Y) | | External (WxHxD) | | |  |
| Product | 481x681 | | 544x1922xØ420 | | | |

*10.479

Graphic Size: 500x700

COMBI ONE 2SIDED

* W: Width H: Height D: Depth *mm

| | QTY | N.W | G.W | C.B.M | Size (WxHxD) | |
|---------|--------------|--------|------------------|--------|--------------|--|
| Packing | 1 | 2.8kg | 3.6kg | 0.0123 | 80x1920x80 |  x6 |
| | 1 | 8.2kg | 8.5kg | 0.0097 | 440x440x50 | |
| | 2 | 1.95kg | 2.2kg | 0.0089 | 380x470x50 | |
| | 2 | 1.95kg | 2.4kg | 0.0104 | 560x745x25 | |
| | Visual (X-Y) | | External (WxHxD) | | |  |
| Product | 481x681 | | 544x1922xØ420 | | | |

*10.480

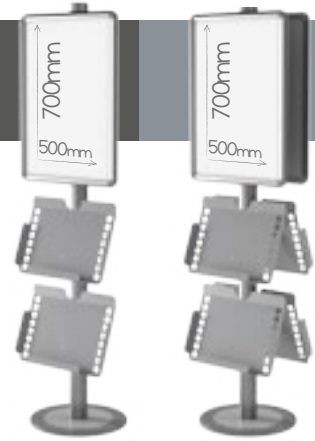

Graphic Size: 500x700 (x2)

COMBI TWO



COMBI TWO 1SIDED

* W: Width H: Height D: Depth *mm



| | QTY | N.W | G.W | C.B.M | Size (WxHxD) | |
|---------|--------------|--------|------------------|--------|--------------|--|
| Packing | 1 | 2.8kg | 3.6kg | 0.0123 | 80x1920x80 |  x5 |
| | 1 | 8.2kg | 8.5kg | 0.0097 | 440x440x50 | |
| | 2 | 1.95kg | 2.2kg | 0.0089 | 380x470x50 | |
| | 1 | 1.95kg | 2.4kg | 0.0104 | 560x745x25 | |
| | Visual (X-Y) | | External (WxHxD) | | |  |
| Product | 481x681 | | 544x1922xØ420 | | | |

*10.485

Graphic Size: 500x700

COMBI TWO 2SIDED

* W: Width H: Height D: Depth *mm



| | QTY | N.W | G.W | C.B.M | Size (WxHxD) | |
|---------|--------------|--------|------------------|--------|--------------|--|
| Packing | 1 | 2.8kg | 3.6kg | 0.0123 | 80x1920x80 |  x8 |
| | 1 | 8.2kg | 8.5kg | 0.0097 | 440x440x50 | |
| | 4 | 1.95kg | 2.2kg | 0.0089 | 380x470x50 | |
| | 2 | 1.95kg | 2.4kg | 0.0104 | 560x745x25 | |
| | Visual (X-Y) | | External (WxHxD) | | |  |
| Product | 481x681 | | 544x1922xØ420 | | | |

*10.486

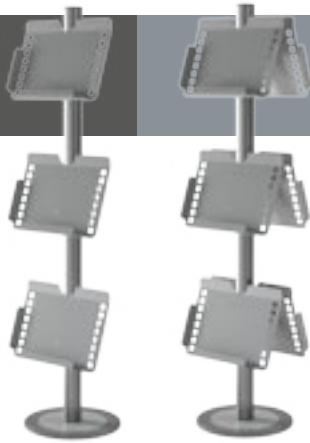

Graphic Size: 500x700 (x2)

COMBI THREE



| COMBI THREE 1SIDED | | | | | | * W: Width | H: Height | D: Depth | *mm |
|--------------------|------------------|--------|-------|--------|--------------|--|-----------|----------|-----|
| | QTY | N.W | G.W | C.B.M | Size (WxHxD) | | | | |
| Packing | 1 | 2.8kg | 3.6kg | 0.0123 | 80x1920x80 |  x5 | | | |
| | 1 | 8.2kg | 8.5kg | 0.0097 | 440x440x50 | | | | |
| | 3 | 1.95kg | 2.2kg | 0.0089 | 380x470x50 | | | | |
| Product | External (WxHxD) | | | | |  | | | |
| | 460x1922xØ420 | | | | | | | | |



***10.483**

| COMBI THREE 2SIDED | | | | | | * W: Width | H: Height | D: Depth | *mm |
|--------------------|------------------|--------|-------|--------|--------------|--|-----------|----------|-----|
| | QTY | N.W | G.W | C.B.M | Size (WxHxD) | | | | |
| Packing | 1 | 2.8kg | 3.6kg | 0.0123 | 80x1920x80 |  x8 | | | |
| | 1 | 8.2kg | 8.5kg | 0.0097 | 440x440x50 | | | | |
| | 6 | 1.95kg | 2.2kg | 0.0089 | 380x470x50 | | | | |
| Product | External (WxHxD) | | | | |  | | | |
| | 544x1922xØ420 | | | | | | | | |

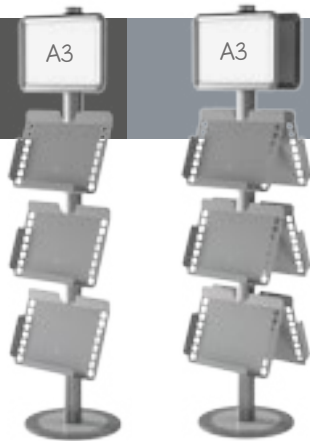

***10.484**

COMBI MIX



| COMBI MIX 1SIDED | | | | | | * W: Width | H: Height | D: Depth | *mm |
|------------------|--------------|--------|------------------|--------|--------------|--|-----------|----------|-----|
| | QTY | N.W | G.W | C.B.M | Size (WxHxD) | | | | |
| Packing | 1 | 2.8kg | 3.6kg | 0.0123 | 80x1920x80 |  x6 | | | |
| | 1 | 8.2kg | 8.5kg | 0.0097 | 440x440x50 | | | | |
| | 3 | 1.95kg | 2.2kg | 0.0089 | 380x470x50 | | | | |
| | 1 | 1kg | 1.2kg | 0.0061 | 365x480x35 | | | | |
| Product | Visual (X-Y) | | External (WxHxD) | | |  | | | |
| | 481x681 | | 544x1922xØ420 | | | | | | |



***10.487** Graphic Size: A3

| COMBI MIX 2SIDED | | | | | | * W: Width | H: Height | D: Depth | *mm |
|------------------|--------------|--------|------------------|--------|--------------|---|-----------|----------|-----|
| | QTY | N.W | G.W | C.B.M | Size (WxHxD) | | | | |
| Packing | 1 | 2.8kg | 3.6kg | 0.0123 | 80x1920x80 |  x10 | | | |
| | 1 | 8.2kg | 8.5kg | 0.0097 | 440x440x50 | | | | |
| | 6 | 1.95kg | 2.2kg | 0.0089 | 380x470x50 | | | | |
| | 2 | 1kg | 1.2kg | 0.0061 | 365x480x35 | | | | |
| Product | Visual (X-Y) | | External (WxHxD) | | |  | | | |
| | 278x402 | | 460x1922xØ420 | | | | | | |

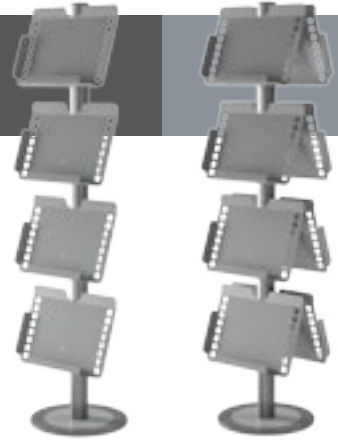

***10.488** Graphic Size: A3 (x2)

COMBI FOUR



| COMBI FOUR 1SIDED | | | | | | * W: Width | H: Height | D: Depth | *mm |
|-------------------|------------------|--------|-------|--------|--------------|--|-----------|----------|-----|
| | QTY | N.W | G.W | C.B.M | Size (WxHxD) | | | | |
| Packing | 1 | 2.8kg | 3.6kg | 0.0123 | 80x1920x80 |  x6 | | | |
| | 1 | 8.2kg | 8.5kg | 0.0097 | 440x440x50 | | | | |
| | 4 | 1.95kg | 2.2kg | 0.0089 | 380x470x50 | | | | |
| Product | External (WxHxD) | | | | |  | | | |
| | 544x1922xØ420 | | | | | | | | |

***10.481**

| COMBI FOUR 2SIDED | | | | | | * W: Width | H: Height | D: Depth | *mm |
|-------------------|------------------|--------|-------|--------|--------------|---|-----------|----------|-----|
| | QTY | N.W | G.W | C.B.M | Size (WxHxD) | | | | |
| Packing | 1 | 2.8kg | 3.6kg | 0.0123 | 80x1920x80 |  x10 | | | |
| | 1 | 8.2kg | 8.5kg | 0.0097 | 440x440x50 | | | | |
| | 8 | 1.95kg | 2.2kg | 0.0089 | 380x470x50 | | | | |
| Product | External (WxHxD) | | | | |  | | | |
| | 544x1922xØ420 | | | | | | | | |

***10.482**

COMBI FRAME

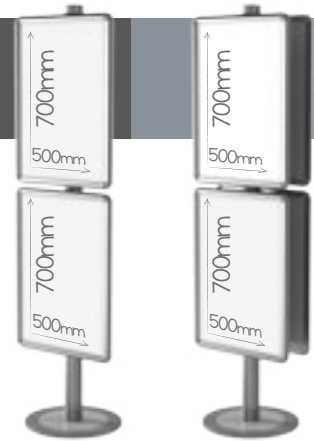

| COMBI FRAME 1SIDED | | | | | | * W: Width | H: Height | D: Depth | *mm |
|--------------------|--------------|--------|------------------|--------|--------------|--|-----------|----------|-----|
| | QTY | N.W | G.W | C.B.M | Size (WxHxD) | | | | |
| Packing | 1 | 2.8kg | 3.6kg | 0.0123 | 80x1920x80 |  x4 | | | |
| | 1 | 8.2kg | 8.5kg | 0.0097 | 440x440x50 | | | | |
| | 2 | 1.95kg | 2.4kg | 0.0104 | 560x745x25 | | | | |
| Product | Visual (X-Y) | | External (WxHxD) | | |  | | | |
| | 481x681 | | 544x1922xØ420 | | | | | | |

***10.489** Graphic Size: 500x700

| COMBI FRAME 2SIDED | | | | | | * W: Width | H: Height | D: Depth | *mm |
|--------------------|--------------|---------------|------------------|--------|--------------|--|-----------|----------|-----|
| | QTY | N.W | G.W | C.B.M | Size (WxHxD) | | | | |
| Packing | 1 | 2.8kg | 3.6kg | 0.0123 | 80x1920x80 |  x6 | | | |
| | 1 | 8.2kg | 8.5kg | 0.0097 | 440x440x50 | | | | |
| | 4 | 1.95kg | 2.4kg | 0.0104 | 560x745x50 | | | | |
| | Visual (X-Y) | | External (WxHxD) | | | | | | |
| 481x681 | | 544x1922xØ420 | | | | | | | |

***10.490** Graphic Size: 500x700 (x2)

TABLET STAND | Table Stand



INFORMATION

* W: Width H: Height D: Depth * mm

This stylish secure tablet floor stand is designed for both sitting and standing thanks its telescopic pole. It has a stunning black finish. Also, an anti-theft system keeps the technology safely locked for secured public use and provides owners with a key for access. Users may easily rotate 360° or tilt the bracket of the adjustable tablet floor stand for different viewing angles. Tablet Holder has foam pads for a better grip and to prevent the scratches. The touchscreen holder's unique design allows access to the home and power buttons while also leaving the auxiliary port open, perfect for credit card readers. Ideal for trade shows, academies, exhibitions or events.

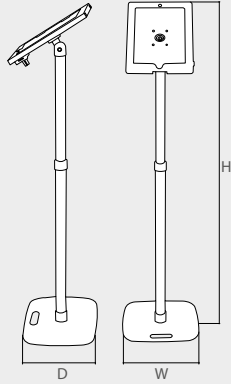

TABLET STAND

* W: Width H: Height D: Depth *mm

| | QTY | N.W | G.W | C.B.M | Size (WxHxD) |
|----------------|-----------------------------|-----|--------|-------|---|
| Packing | 1 | 4kg | 4.25kg | 0.037 | 395x760x125 |
| | External (WxHxD) | | | | |
| Product | 245x1350x280 | | | |  |
| *10.306 | For Tablet: ± 242.8x189.7mm | | | | |

TABLET STAND

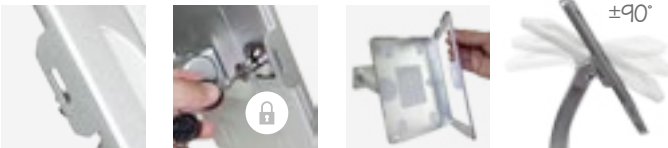

INFORMATION

* W: Width H: Height D: Depth * mm

This Support for tablets is designed for desk or wall mounting. Also, an anti-theft system keeps the technology safely locked for secured public use and provides owners with a key for access. Tablet Holder has foam pads for a better grip and to prevent the scratches. The touchscreen holder's unique design allows access to the home and power buttons while also leaving the auxiliary port open, perfect for credit card readers. Users may easily rotate 90° the bracket for different viewing angles. Ideal for mounting your device in stores, trade shows, academies or events.

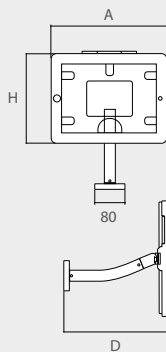

TABLET SUPPORT FOR WALL OR DESK



TABLET WALL | DESK

* W: Width H: Height D: Depth *mm

| | QTY | N.W | G.W | C.B.M | Size (WxHxD) |
|----------------|-------------------------|-----|--------|-------|---|
| Packing | 1 | 1kg | 1.55kg | 0.006 | 365x92x204 |
| | External (WxHxD) | | | | |
| Product | 248x194x270 | | | |  |
| *14.108 | For Tablet: ± 240x185mm | | | | |

SLIGO METALLIC



INFO * W: Width H: Height D: Depth

The Sligo Lectern is available with a metallic double-A4 reading surface for displaying documents or menus thanks to its brochure holder rings. Sligo is perfect for auditoriums, restaurant entrances or for convention centers.

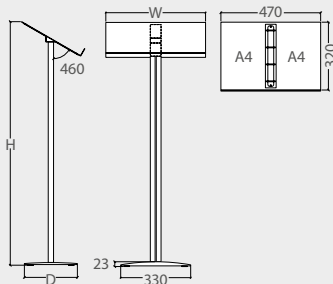

metallic ring binder

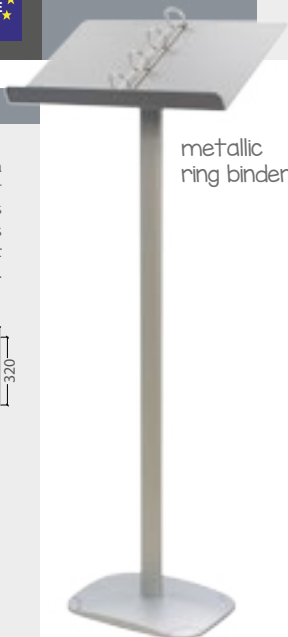

SLIGO ACRYLIC



INFO * W: Width H: Height D: Depth

Also, Sligo Lectern is available with an acrylic double-A4 reading surface for displaying documents or menus thanks to its brochure holder rings. Sligo is perfect for auditoriums, restaurant entrances or for convention centers.

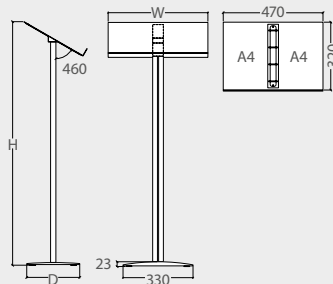

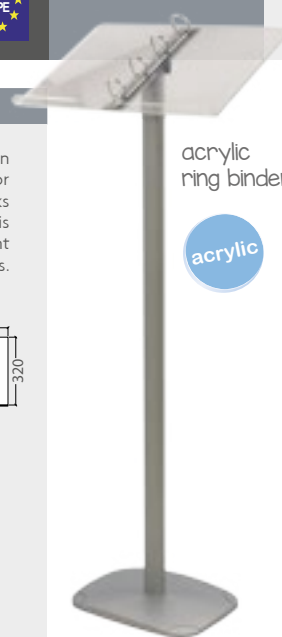

acrylic ring binder





SLIGO METALLIC

* W: Width H: Height D: Depth *mm

| | QTY | N.W | G.W | C.B.M | Size (WxHxD) | |
|--|----------------------------|--------|-------|--------|--------------|--|
| Packing | 1 | 4.3kg | 4.7kg | 0.0107 | 330x500x65 |  x2 |
| | 1 | 1.15kg | 1.3kg | 0.0028 | 40x1070x65 | |
| | External (WxHxD) | | | | |  |
| Product | 470x1147x250 | | | | | |
|  10.984 | Literature Holder: A4 (x2) | | | | | |

SLIGO ACRYLIC

* W: Width H: Height D: Depth *mm

| | QTY | N.W | G.W | C.B.M | Size (WxHxD) | |
|--|----------------------------|--------|-------|--------|--------------|--|
| Packing | 1 | 2.75kg | 3kg | 0.0107 | 330x500x65 |  x2 |
| | 1 | 1.15kg | 1.3kg | 0.0028 | 40x1070x65 | |
| | External (WxHxD) | | | | |  |
| Product | 470x1147x250 | | | | | |
|  10.983 | Literature Holder: A4 (x2) | | | | | |

EN Extendable aluminium tripod. Ideal for using with aluminium frames.

FR Trépied extensible, en aluminium. Idéal pour y placer des cadres.

PT Tripé extensível em alumínio. Ideal para colocação de marcos.

ES Trípode extensible, en aluminio. Ideal para la colocación de marcos.

INFORMATION

* W: Width H: Height D: Depth * mm

Solana is made with an aluminum alloy that is strong and stable, featuring adjustable height, so its telescopic legs can be shortened for table top use or lengthened for a floor standing display. This telescoping aluminum easel is a versatile method to use for any type of showcase. Whether you're travelling for tradeshows or art exhibits, use this silver telescoping easel for a durable, yet convenient tool to display your work.

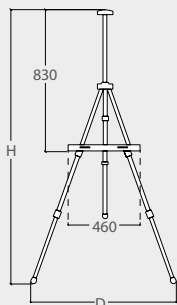

SOLANA







telescopic



SOLANA

* W: Width H: Height D: Depth *mm

| | QTY | N.W | G.W | C.B.M | Size (WxHxD) | |
|--|------------------------|------------------|--------|--------|--------------|---|
| Packing | 1 | 0.65kg | 0.75kg | 0.0035 | 80x560x80 |   |
| | | External (WxHxD) | | | | |
| Product | 780x1605x900 | | | | |  |
|  10.816 | Height: 1605mm Maximum | | | | | |



ALUMINIUM LECTERN



19mm thickness white wooden



* W: Width H: Height D: Depth * mm

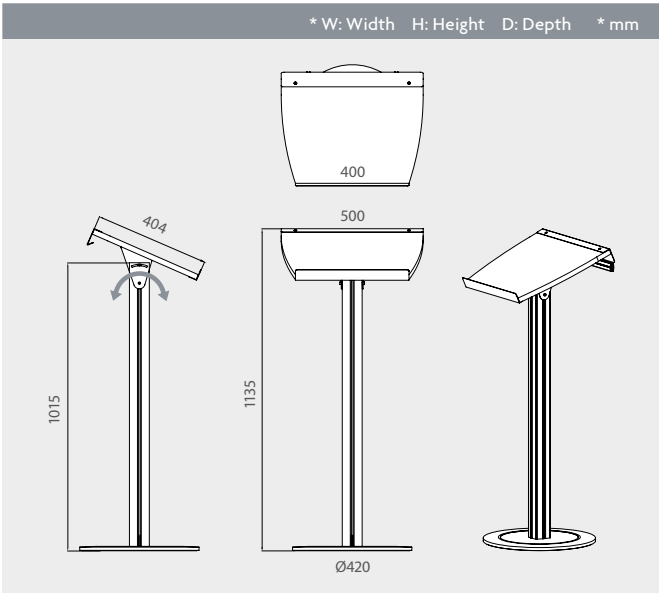

INFORMATION

* W: Width H: Height D: Depth * mm

This aluminium lectern includes a 19mm thickness white wooden reading surface with a matching aluminum post and circular base offering modern visual displays. The reading surface on this lectern includes a book stop to support your notes during a presentation for award recipients, sheet music for a performance, or a seating chart to assist a hostess, also it features an adjustable angle view for the reading surface. With its sleek contemporary design, this podium is easy to assemble, requiring only a screwdriver and a few minutes. Its silver aluminum pole and base are durable and will last through years of performances and presentations. This stylish yet affordable lectern is a great addition to any presentation space, such as auditoriums, restaurants for menu displays or convention centers to attract the attention of your audience.



i OPTIONAL ACCESSORY

The back of the surface of this Lectern provides the possibility of attaching an Alulon Poster System (Ref: 10571) to place a banner and customize the look of the lectern. For more information, see the article in chapter 1 of this catalog.

ALUMINIUM LECTERN

* W: Width H: Height D: Depth * mm

| | QTY | N.W | G.W | C.B.M | Size (WxHxD) |  x3 |
|---------|------------------|--------|--------|--------|--------------|--|
| Packing | 1 | 8.2kg | 8.5kg | 0.0097 | 440x440x50 | |
| | 1 | 1.59kg | 1.75kg | 0.0067 | 80x80x1040 | |
| | 1 | 3.95kg | 4.7kg | 0.0413 | 530x445x175 | |
| | External (WxHxD) | | | | | |
| Product | ± 500x1135x420 | | | | | |

✱ 13.640

 **no tools required!**  **no screws!**



FAST WOODEN LECTERN



NEW



* Tablet not included

* W: Width H: Height D: Depth * mm

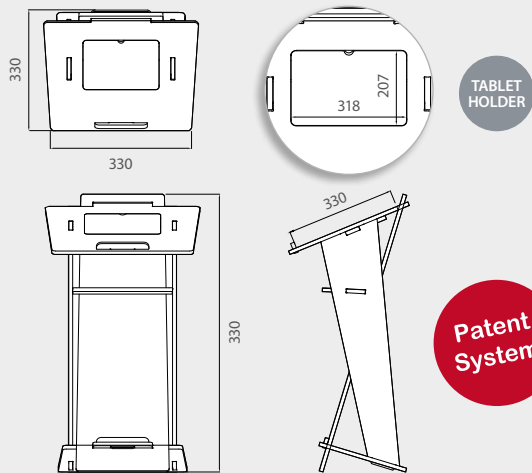

INFORMATION

* W: Width H: Height D: Depth * mm

This stunning wooden lectern does not require the use of any tools for its assembly thanks its Patent System. Each of its 10 pieces is designed to complete a sturdy and firm structure in very few steps. It is made of 16mm thickness Waterproof MDF Wood with a natural stylish grey finish. It features one shelf in the interior of the lectern, so this way, the extra brochures, business cards and documents can be stored out of sight so your exhibition always appears clean and organized. Also, it features a 318x207mm holder at the top surface for placing securely a tablet. The Fast Wooden Lectern is ideal for being used in auditoriums or convention centers to attract the attention of your audience.

10 MANUALLY ATTACHABLE PARTS



WOODEN LECTERN

*mm

| | QTY | N.W | G.W | C.B.M | Size (WxHxD) |
|---------|-----|------|---------|--------|--------------|
| Packing | 1 | 19kg | 21.41kg | 0.0832 | 605x105x1310 |

✻ 13.641

BROCHURE STAND | RESIST Brochure Stand

EN Brochure and catalogue stands for A4 or A5 formats, made in different materials.

FR Support pour brochure et catalogue au format A4 ou A5. Différents matériaux.

PT Porta folhetos ou catálogos em formatos A4 ou A5. Disponíveis em vários materiais.

ES Portafolletos y portacatálogos para formatos A4 o A5, en diferentes materiales.

SAGRES ACRYLIC

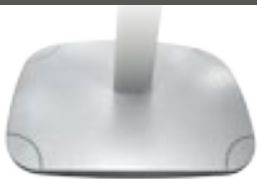

acrylic



* W: Width H: Height D: Depth * mm

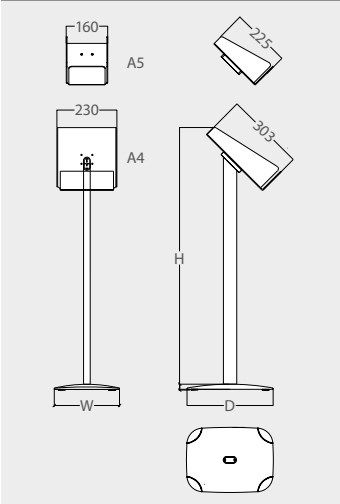

SAGRES METALLIC

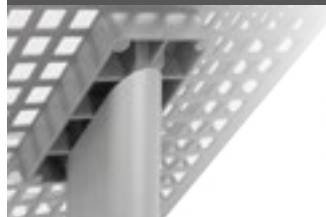

steel



* W: Width H: Height D: Depth * mm

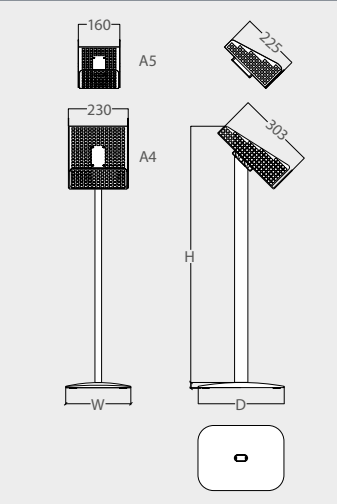

INFORMATION

* W: Width H: Height D: Depth * mm

The Sagres brochure tray stand features an acrylic literature holder available for A4 or A5 format documents, an aluminium profile structure with a highly resistant and solid base, which ensures that the unit stays upright in heavily trafficked areas. The silver finish provides a neutral tone that will complement any commercial environment. Sagres as holder of informational catalogs, flyers, brochures or promotional documents is ideal for tradeshows, mall stores, exhibitions, media events or places with a high traffic area.

INFORMATION

* W: Width H: Height D: Depth * mm

Also, Sagres brochure tray stand features an steel literature holder available for A4 or A5 format documents, an aluminium profile structure with a highly resistant and solid base, which ensures that the unit stays upright in heavily trafficked areas. The silver finish provides a neutral tone that will complement any commercial environment. Sagres as holder of informational catalogs, flyers, brochures or promotional documents is ideal for tradeshows, mall stores, exhibitions, media events or places with a high traffic area.

SAGRES ACRYLIC

* W: Width H: Height D: Depth * mm

| | QTY | N.W | G.W | C.B.M | Size (WxHxD) |
|---------|------------------|-------|-------|--------|--------------|
| Packing | 1 | 3.1kg | 3.4kg | 0.0322 | 295x120x910 |
| | External (WxHxD) | | | | |
| Product | ± 250x1000x330 | | | | |



NEW

✿ 13.775

BROCHURE HOLDER SIZE: A5

✿ 10.473

BROCHURE HOLDER SIZE: A4

SAGRES METALLIC

* W: Width H: Height D: Depth * mm

| | QTY | N.W | G.W | C.B.M | Size (WxHxD) |
|---------|------------------|-------|-------|--------|--------------|
| Packing | 1 | 3.2kg | 3.5kg | 0.0322 | 295x120x910 |
| | External (WxHxD) | | | | |
| Product | ± 250x1000x330 | | | | |

NEW

✿ 13.776

BROCHURE HOLDER SIZE: A5

✿ 10.474

BROCHURE HOLDER SIZE: A4

BROCHURE STAND | RESIST Leaflet Stand | Ballot Box Stand

EN Leaflet dispenser and ballot box stands made in acrylic / polystyrene and aluminium structure. Decorative interchangeable cover for the base.
 FR Porte-brochure avec un support pour urne fabriqué en acrylique / polystyrène et aluminium. L'élément décoratif du socle est interchangeable.

PT Porta-folhetos com suporte para urna, fabricado em acrílico / poliestireno e alumínio. Possui um elemento decorativo na base que se pode mudar.
 ES Portafolletos y stand para urna, realizados en acrílico / poliestireno y estructura en aluminio. Elemento decorativo intercambiable para la base.

LEAFLET DISPENSER STAND

MADE IN EUROPE

polystyrene

+ 2 extra discs included

A4 pocket holders

* H: Height D: Diameter * mm

| Format | Number of Pockets | Height (mm) | Depth (mm) |
|--------|-------------------|-------------|------------|
| A5 | 4 | 255 | 160 |
| A4 | 3 | 325 | 155 |

5 kg base

BALLOT BOX STAND

MADE IN EUROPE

+ 2 extra discs included

acrylic

* H: Height D: Diameter * mm

| Dimension | Value (mm) |
|--------------------------|------------|
| Upper Sign Holder Height | 222 |
| Ballot Box Depth | 210 |
| Base Diameter | D |
| Ballot Box Height | H |

5 kg base

INFORMATION * W: Width H: Height D: Depth * mm

This acrylic standing has 2 leaflet dispenser sizes available: A4 (3 pockets) or A5 format (4 pockets) for displaying documents like brochures, flyers, or catalogues. Featuring a solid 5kg base with 2 decorative interchangeable extra covers (included). The acrylic brochure holder arrives in a separate box from the base and pole stand. Simply attach a brochure holder to the pole and you are ready to display promotional literature. These floorstanding leaflet dispenser are also ideal for special promotions at various events, like tradeshows, hotels information, restaurants, retailers, corporate events or places with a high traffic area.

INFORMATION * W: Width H: Height D: Depth * mm

This acrylic standing ballot box is designed for gathering customer feedback, complaints, ideas or contests. Featuring a solid 5kg base with 2 decorative interchangeable covers to customize on red or black color. Also, includes lock system that keeps entries secure and confidential (with keys for access) and an upper A4 format sign holder for promoting the event. These floorstanding ballot boxes are also ideal for raffles and contests at various events. Some of the places that an employee suggestion box can be found are a trade show, corporate events, hotels, restaurants, retailers, etc.

| LEAFLET STAND | | * W: Width | H: Height | D: Depth | *mm |
|---------------|----------------|----------------------------|-----------|----------|--------------|
| | QTY | N.W | G.W | C.B.M | Size (WxHxD) |
| Packing | 1 | 5kg | 5.3kg | 0.0055 | 350x350x45 |
| | 1 | 0.70kg | 0.85kg | 0.0035 | 895x65x37 |
| | 1 | 1.1kg | 1.5kg | 0.0194 | 330x230x260 |
| | External (HxD) | | | | |
| Product | 1170xØ330 | | | | |
| NEW | 13.777 | LEAFLET DISPENSER SIZE: A5 | | | |
| | 14.100 | LEAFLET DISPENSER SIZE: A4 | | | |

| BALLOT BOX | | * W: Width | H: Height | D: Depth | *mm |
|------------|----------------|------------|-----------|----------|--------------|
| | QTY | N.W | G.W | C.B.M | Size (WxHxD) |
| Packing | 1 | 5kg | 5.3kg | 0.0055 | 350x350x45 |
| | 1 | 0.70kg | 0.85kg | 0.0035 | 895x65x37 |
| | 1 | 1.7kg | 2.4kg | 0.0332 | 380x265x330 |
| | External (HxD) | | | | |
| Product | 1323xØ330 | | | | |
| | 14.101 | | | | |

with header top for customizing with logo



INFORMATION

* W: Width H: Height D: Depth * mm

This Brochure Stand features a strong and stable design and it is made of steel with a silver finish to easily match any environment. Featuring a top holder which allows the placement of 2x A4 wide documents. It also organizes and displays your magazines in an orderly manner with an open-front design for customers to easily access the publications. This Brochure Stand is used to display A4 format. Bari is ideal for displaying travel magazines, real estate booklets, autos-for-sale publications, business catalogues and other types of literature.

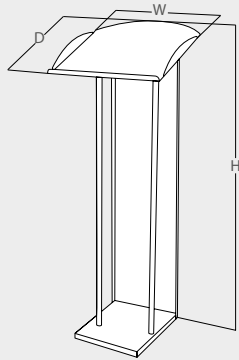

BARI



stand top allows the placement of 2x A4

ideal for catalogues

made of steel

BARI

* W: Width H: Height D: Depth * mm

| | QTY | N.W | G.W | C.B.M | Size (WxHxD) |
|----------|------------------|-------|------|--------|--------------|
| Packing | 1 | 8.6kg | 11kg | 0.3125 | 500x1250x500 |
| | External (WxHxD) | | | | |
| Product | 455x1210x450 | | | | |
| ❁ 10.219 | | | | | |

made of plastic and chromed steel



INFORMATION

* W: Width H: Height D: Depth * mm

Vegas Brochure Stand offers the looks and stability of a permanent fixture and the versatility of a portable stand. Featuring 4x A4 format pockets. This foldable silver tradeshow literature rack can be stored with pamphlets and magazines in the pockets, even when the unit is collapsed and stowed away. Set up is simple, just taking the unit out of the carrying bag and pulling the pockets upward. This unique design is perfect for businesses that regularly attend conventions, tradeshows, exhibitions, media events or places with a high traffic area. Also with such a lightweight design, this tradeshow literature rack will quickly become a vital component of your booth system.

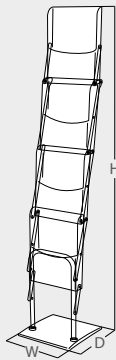

VEGAS



A4 format

foldable

VEGAS

* W: Width H: Height D: Depth * mm

| | QTY | N.W | G.W | C.B.M | Size (WxHxD) |
|----------|------------------|-----|-----|-------|--------------|
| Packing | 1 | 6kg | 8kg | 0.067 | 380x470x380 |
| | External (WxHxD) | | | | |
| Product | 280x1605x260 | | | | |
| ❁ 10.048 | | | | | |

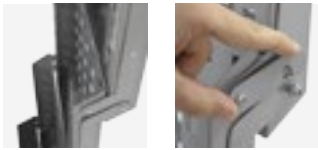

with carry-bag

INFORMATION

* W: Width H: Height D: Depth * mm

Soubran is designed to be mobile and compact. In this model it features 5 portrait steel pockets which are designed to accommodate A4 portrait format documents. This tradeshow literature rack can be stored with pamphlets and magazines in the pockets, even when the unit is collapsed and stowed away. This brochure stand folds up into a small, lightweight unit. Also, for a simple transportation it includes a nylon carry-bag. With such a lightweight, simple design, this tradeshow literature rack will quickly become a vital component of your booth system. Soubran features a front bottom space which can be used to place a graphic. Use this portable literature stand as a literature display at trade shows, conventions, exhibitions, retail outlets or showroom floors to attract customers looking for additional information.

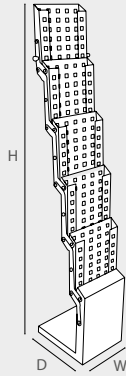

SOUBRAN

* W: Width H: Height D: Depth

*mm

| | QTY | N.W | G.W | C.B.M | Size (WxHxD) |
|---------|------------------|-----|------|-------|--------------|
| Packing | 1 | 8kg | 10kg | 0.148 | 550x770x350 |
| | External (WxHxD) | | | | |
| Product | 230x1420x290 | | | | |

❁ 10.416

SOUBRAN

5x A4 portrait steel shelves

steel structure

foldable

the bottom can be used to place a graphic



with carry-bag

INFORMATION

* W: Width H: Height D: Depth * mm

Colmenar is designed to be mobile and compact. In this model it features 5 portrait acrylic pockets which are designed to accommodate A4 portrait format documents. This tradeshow literature rack can be stored with pamphlets and magazines in the pockets, even when the unit is collapsed and stowed away. This brochure stand folds up into a small, lightweight unit. Also, for a simple transportation it includes a nylon carry-bag. With such a lightweight, simple design, this tradeshow literature rack will quickly become a vital component of your booth system. Colmenar features a front bottom space which can be used to place a graphic. Use this portable literature stand as a literature display at trade shows, conventions, exhibitions, retail outlets or showroom floors to attract customers looking for additional information.

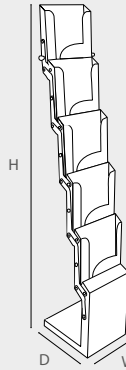

COLMENAR

* W: Width H: Height D: Depth

*mm

| | QTY | N.W | G.W | C.B.M | Size (WxHxD) |
|---------|------------------|-----|-----|-------|--------------|
| Packing | 1 | 5kg | 7kg | 0.148 | 550x770x350 |
| | External (WxHxD) | | | | |
| Product | 230x1420x290 | | | | |

❁ 13.718

COLMENAR

5x A4 portrait acrylic shelves

steel structure

minimal storage space

the bottom can be used to place a graphic



nylon bag
option 13.717



Foldable



SAHAGUN



5x A4
portrait
shelves

stable base
by secure
system



* W: Width H: Height D: Depth * mm

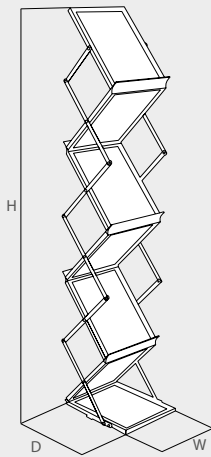

option 1
13.717 Nylon Bag



option 2
10.047 Briefcase

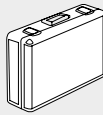

INFORMATION

Sahagun is designed to be mobile and compact. It has a zigzag design that folds down into a small unit. Featuring 5x A4 format literature holders for displaying. The literature holders provide a multi-level display system with an unobstructed view of magazines, brochures or any other periodicals you wish to display, also it is very lightweight thanks to its aluminium structure and acrylic holders. This brochure stand folds up into a small, lightweight unit. For a simple transportation you can choose between the nylon carry-bag or the deluxe briefcase option, which has reinforced foam padded. Use this portable literature stand as a single or double sided display at trade shows, retail outlets, or showroom floors to attract customers looking for additional information.

SAHAGUN * W: Width H: Height D: Depth * mm

| | QTY | N.W | G.W | C.B.M | Size (WxHxD) |
|----------|--|--------|--------|--------|--------------|
| Packing | 1 | 7.35kg | 7.95kg | 0.0293 | 360x480x170 |
| | External (WxHxD) | | | | |
| Product | 260x1490x350  | | | | |
| * 13.717 | Nylon Travel Bag | | | | |
| * 10.047 | Briefcase | | | | |



briefcase
option 10.047



with secure system

INFORMATION

* W: Width H: Height D: Depth * mm

This Brochure Stand features a strong and stable design with a black finish to easily match any environment. Featuring a top header and a front bottom area which allows the placement of graphics. It also organizes and displays your magazines in an orderly manner with an open-front design for customers to easily access the publications. The Mentrída Stand features 5 pockets for displaying A4 portrait format documents. Mentrída is ideal for travel magazines, real estate booklets, autos-for-sale publications, bussiness catalogues and other types of literature These displays are also great for use at libraries, schools, hospitals or doctors' offices.



MENTRIDA

5x A4 portrait pockets

made in black painted steel

the bottom can be used to place a graphic



MENTRIDA

* W: Width H: Height D: Depth * mm

| | QTY | N.W | G.W | C.B.M | Size (WxHxD) |
|---------|------------------|-------|-------|--------|--------------|
| Packing | 1 | 4.2kg | 5.1kg | 0.0565 | 120x1520x310 |
| | External (WxHxD) | | | | |
| Product | 250x1465x470 | | | | |

❖ 10.720

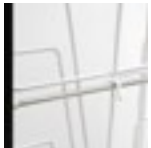

1370mm height

INFORMATION

* W: Width H: Height D: Depth * mm

This Brochure Stand features a strong and stable design with a black finish to easily match any environment. Featuring a top header and a front bottom area which allows the placement of graphics. It also organizes and displays your magazines in an orderly manner with an open-front design for customers to easily access the publications. This Stand features 7 pockets for displaying A4 portrait format documents. Bañeza is ideal for travel magazines, real estate booklets, autos-for-sale publications, bussiness catalogues and other types of literature These displays are also great for use at libraries, schools, hospitals or doctors' offices.



BAÑEZA

7x A4 portrait pockets

made in black painted steel

the bottom can be used to place a graphic



BAÑEZA

* W: Width H: Height D: Depth * mm

| | QTY | N.W | G.W | C.B.M | Size (WxHxD) |
|---------|------------------|-------|-------|--------|--------------|
| Packing | 1 | 2.9kg | 3.6kg | 0.0532 | 100x1420x375 |
| | External (WxHxD) | | | | |
| Product | 280x1370x370 | | | | |

❖ 10.044



quick and simple mounting

INFORMATION

* W: Width H: Height D: Depth * mm

With a lightweight design and an easy setup Sil Brochure Stand is perfect for exhibitors who need a lightweight and portable display for their tradeshow booth. This magazine stand is made of black mesh and has 4 pockets for A4 Portrait format documents. Featuring an elastic design to the pockets that keeps reading materials secure and erect while on display. No additional tools are required to set up or take down this portable tradeshow accessory. Includes carrying-bag. Sil is ideal for travel magazines, autos-for-sale publications, bussiness catalogues and other types of literature These displays are also great for use at libraries, schools or offices.

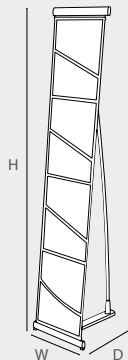

SIL SIMPLE

4x A4 pockets

made of nylon and aluminium



SIL SIMPLE

* W: Width H: Height D: Depth *mm

| | QTY | N.W | G.W | C.B.M | Size (WxHxD) |
|---|------------------|--------|--------|--------|--------------|
| Packing | 1 | 1.05kg | 1.20kg | 0.0086 | 120x600x120 |
| | External (WxHxD) | | | | |
| Product | 270x1360x380 | | | | |
|  10.051 | 4 x A4 Pockets | | | | |



quick and simple mounting

INFORMATION

* W: Width H: Height D: Depth * mm

With a lightweight design and an easy setup Sil Double Brochure Stand is perfect for exhibitors who need a lightweight and portable display for their tradeshow booth. This magazine stand is made of black mesh and has 8 pockets for A4 Portrait format documents. Featuring an elastic design to the pockets that keeps reading materials secure and erect while on display. No additional tools are required to set up or take down this portable tradeshow accessory. Includes carrying-bag. Sil is ideal for travel magazines, autos-for-sale publications, bussiness catalogues and other types of literature These displays are also great for use at libraries, schools or offices.

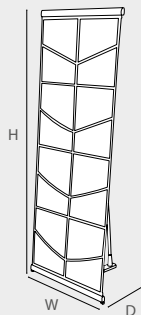

SIL DOUBLE

8x A4 pockets

made of nylon and aluminium

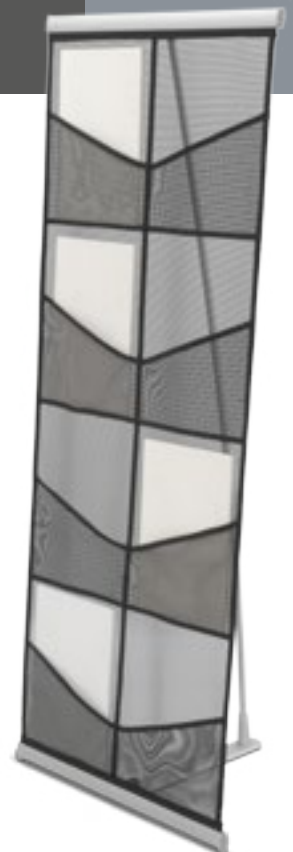

SIL DOUBLE

* W: Width H: Height D: Depth *mm

| | QTY | N.W | G.W | C.B.M | Size (WxHxD) |
|--|------------------|-------|--------|--------|--------------|
| Packing | 1 | 1.4kg | 1.55kg | 0.0086 | 120x600x120 |
| | External (WxHxD) | | | | |
| Product | 545x1360x380 | | | | |
|  10.050 | 8 x A4 Pockets | | | | |

BROCHURE STAND | Brochure Stand



made of acrylic and aluminium

INFORMATION

* W: Width H: Height D: Depth * mm

The combination of contemporary design, durability and portability make Legnica display one of the best options for literature displaying. Featuring a front bottom area which allows the placement of a logo. Its design allows you to leave literature inside the pockets when the unit is collapsed. This Stand features 8 pockets for displaying A4 portrait format documents. Legnica Stand is ideal for travel magazines, real estate booklets, autos-for-sale publications, bussiness catalogues and other types of literature and also they are great for being used at libraries, schools, hospitals, doctor's offices, tradeshows, conventions or at showroom floors.

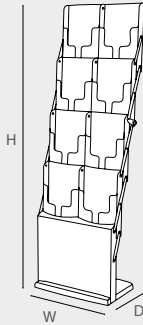

LEGNICA

* W: Width H: Height D: Depth * mm

| | QTY | N.W | G.W | C.B.M | Size (WxHxD) | |
|---------------|-----|------------------|--------|-------|--------------|---|
| Packing | 1 | 14.4kg | 15.5kg | 0.109 | 355x570x540 | |
| | | External (WxHxD) | | | |  |
| Product | | 480x1560x300 | | | | |
| 10.114 | | | | | | |

LEGNICA

8x A4 portrait pockets

includes carry-bag



with wheels

INFORMATION

* W: Width H: Height D: Depth * mm

The Nelas Brochure Stand is designed for an easy rotation and quick selection and can be used to hold magazines, flyers and other publications. With 21 pockets for displaying A4 portrait format documents. Also known as literature holder, is made of lightweight and durable wire. Featuring 5 swivel castors for an easy and comfortable transport. These displays are great for use at libraries, schools, offices, trade shows, conventions, exhibitions, travel agencies, attraction places, waiting rooms, retail outlets or showroom floors.

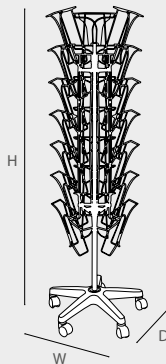

NELAS

21x A4 portrait pockets

made of steel and plastic parts

easy rotation



NELAS

* W: Width H: Height D: Depth * mm

| | QTY | N.W | G.W | C.B.M | Size (WxHxD) | |
|---------------|-----|------------------|---------|-------|--------------|--|
| Packing | 1 | 8kg | 10.05kg | 0.203 | 530x320x1200 | |
| | | External (WxHxD) | | | | |
| Product | | 510x1550x510 | | | | |
| 13.101 | | | | | | |



POLAN
BOARD DISPLAY



made of acrylic
and aluminium

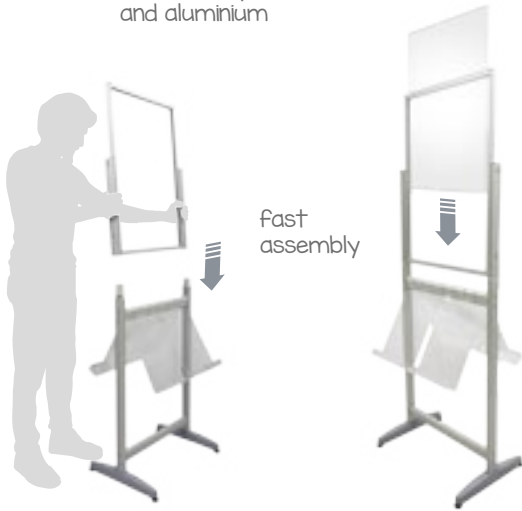

fast
assembly



4x4
brochures
holders

leveling
feet

* W: Width H: Height D: Depth * mm

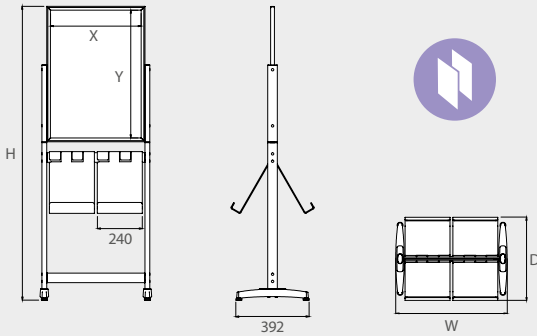

INFORMATION

The Double-sided Polan Board Display is made of aluminium with acrylic shelves. This model has 4 acrylic shelves for 4x4 format literature documents, like brochures, journals, periodicals or newspapers. Also it features an aluminium frame header at the top. With adjustable stability sturdy feet and an easy glide for the graphic poster (9mm maximum thickness) into the metal grooves of the structure and display it back-to-back. Ideal for using in highly-populated lobbies, travel agencies, libraries or waiting rooms to provide reading material to visiting clients.

POLAN * W: Width H: Height D: Depth *mm

| | QTY | N.W | G.W | C.B.M | Size (WxHxD) |  x2 |
|---------------|---------|------------------------------------|------------------|--------|--------------|--|
| Packing | 1 | 6.77kg | 8.47kg | 0.0614 | 880x665x105 | |
| | | Visual (X-Y) | External (WxHxD) | | | |
| Product | 485x683 | | 596.5x1569x446 | | | |
| 13.599 | | Top Header Graphic Size: 500x700mm | | | | |

BROCHURE STAND | Brochure Stand



INFORMATION

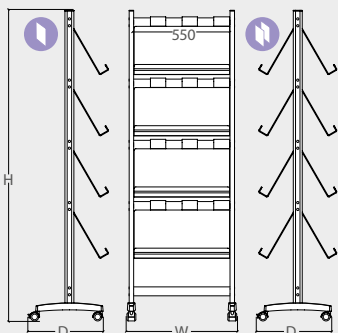

* W: Width H: Height D: Depth * mm

The Cañamo stand with casters is made of aluminium with acrylic shelves. The single-sided model has 4 shelves for 8x4 format documents and double-sided has 8 shelves for 16x44 literature documents, like brochures, journals, periodicals or newspapers. Ideal for using in highly-populated lobbies, travel agencies, libraries or waiting rooms to provide reading material for the visiting clients.



CAÑAMO

* W: Width H: Height D: Depth *mm

| | QTY | N.W | G.W | C.B.M | Size (WxHxD) | |
|---------------|--|-----------------|--------|--------|--------------|--|
| Packing | 1 | 7.3kg | 9kg | 0.0487 | 165x720x410 |  x2 |
| | 1 | 6.45kg | 8.05kg | 0.0772 | 70x1750x630 | |
| | External (WxHxD) | | | | | |
| Product | 629x1769x487 | | | | | |
| 10.468 |  | 1-Sided (8x4) | | | | |
| 14.098 |  | 2-Sided (16x44) | | | | |

CAÑAMO



made of acrylic and aluminium

2 sided available



brake wheels



INFORMATION



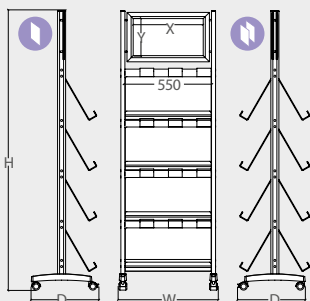

* W: Width H: Height D: Depth * mm

The Abad stand with casters is made of aluminium with acrylic shelves. The single-sided model has 4 shelves for 8x4 format documents and the double-sided has 8 shelves for 16x44 literature documents, like brochures, journals, periodicals or newspapers. Also it features a "Click" frame header at the top. Ideal for using in highly-populated lobbies, travel agencies, libraries or waiting rooms to provide reading material to visiting clients.



ABAD

* W: Width H: Height D: Depth *mm

| | QTY | N.W | G.W | C.B.M | Size (WxHxD) | |
|---------------|---|--|------------------|--------|--------------|--|
| Packing | 1 | 7.3kg | 9kg | 0.0487 | 165x720x410 |  x2 |
| | 1 | 6.45kg | 8.05kg | 0.0772 | 70x1750x630 | |
| | Visual (X-Y) | | External (WxHxD) | | |  |
| Product | 466x236 | | 629x1769x487 | | | |
| 10.467 |  | Top Header Graphic Size: 488x257mm | | | | |
| 14.099 |  | Top Headers Graphic Size: 488x257mm (x2) | | | | |

ABAD



- EN With a "Click" aluminium header frame at the top.
- FR Avec un cadre "Click" dans la partie supérieure.
- PT Possui um marco de abertura "Click" na parte superior.
- ES Dispone de un marco "Click" en su parte superior.

2 sided available



brake wheels





INFORMATION

* W: Width H: Height D: Depth * mm

The Sotillo Brochure Stand with casters is made of aluminium with 4 acrylic shelves for 12xA4 format literature documents, like brochures, journals, periodicals or newspapers. It features a "Click" frame header at the top. Also It is equipped with 4 brake wheels for an effortless repositioning throughout a room or an office. Ideal for using in highly-populated lobbies, travel agencies, libraries or for waiting rooms to provide reading material to the visiting clients.

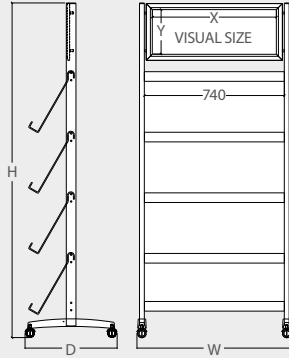

SOTILLO

- EN With a "Click" aluminium header frame at the top.
- FR Avec un cadre "Click" dans la partie supérieure.
- PT Possuium marco de abertura "Click" na parte superior.
- ES Dispone de un marco "Click" en su parte superior.

For 12xA4 brochures



made of acrylic and aluminium

brake wheels



SOTILLO

* W: Width H: Height D: Depth * mm

| | QTY | N.W | G.W | C.B.M | Size (WxHxD) | |
|---------------|-----|--------------|-------------------------|-------|--------------|--|
| Packing | 1 | 9kg | 10.5kg | 0.062 | 410x920x165 |  x2 |
| | 1 | 7.35kg | 9.35kg | 0.101 | 830x1750x70 | |
| | | Visual (X-Y) | External (WxHxD) | | |  |
| Product | | 656x236 | 819x1769x487 | | | |
| 10.469 | | | Graphic Size: 677x257mm | | | |



INFORMATION

* W: Width H: Height D: Depth * mm

Olmedilla Brochure Stand with casters is made of aluminium with 1 acrylic shelf for 3xA4 format literature documents, like brochures, journals or newspapers. It features a double-sided "Click" frame board (2 sizes available). Also It is equipped with 4 brake wheels. Ideal for using in highly-populated lobbies, travel agencies, libraries or for waiting rooms to provide reading material to the visiting clients.

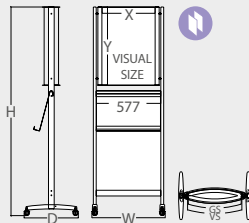

OLMEDILLA

double sided

- EN With a "Click" aluminium header frame at the top.
- FR Avec un cadre "Click" dans la partie supérieure.
- PT Possui um marco de abertura "Click" na parte superior.
- ES Dispone de un marco "Click" en su parte superior.



made of acrylic and aluminium

brake wheels





OLMEDILLA H700

* W: Width H: Height D: Depth * mm

| | QTY | N.W | G.W | C.B.M | Size (WxHxD) | |
|---------------|-----|--------------|------------------------------------|-------|--------------|---|
| Packing | 1 | 11.5kg | 13.4kg | 0.243 | 1825x205x650 |  |
| | | Visual (X-Y) | External (WxHxD) | | | |
| Product | | 476x696 | 655x1864x487 | | |  |
| 10.472 | | | Top Header Graphic Size: 500x700mm | | | |

OLMEDILLA H1000

* W: Width H: Height D: Depth * mm

| | QTY | N.W | G.W | C.B.M | Size (WxHxD) | |
|---------------|-----|--------------|-------------------------------------|-------|--------------|---|
| Packing | 1 | 17kg | 18.5kg | 0.372 | 850x1825x240 |  |
| | | Visual (X-Y) | External (WxHxD) | | | |
| Product | | 690x996 | 856x1864x487 | | |  |
| 10.273 | | | Top Header Graphic Size: 700x1000mm | | | |

BROCHURE STAND | Brochure Stand



VERONA 4xA4

with acrylic header at the top

INFORMATION

* W: Width H: Height D: Depth * mm

The Verona 4xA4 Brochure Stand with casters is made of aluminium with acrylic shelves. This model has 4 shelves for A4 format documents, like brochures, journals, periodicals or newspapers. Also it has a top acrylic header for a 255x147mm graphic. This mobile Brochure Stand is ideal for using in highly-populated lobbies, travel agencies, libraries or for waiting rooms to provide reading material to the visiting clients.

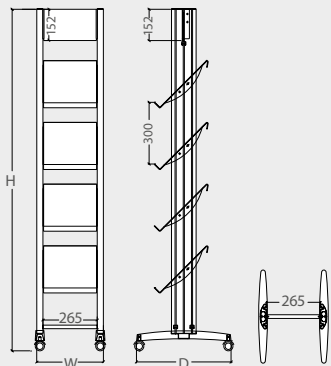

with 4xA4 brochures



brake wheels



VERONA 4xA4

* W: Width H: Height D: Depth * mm

| | QTY | N.W | G.W | C.B.M | Size (WxHxD) |  x2 |
|---------|------------------|--------|--------|--------|--------------|--|
| Packing | 1 | 3kg | 3.95kg | 0.0307 | 420x430x170 | |
| | 1 | 4.45kg | 5kg | 0.0118 | 145x1620x80 | |
| | External (WxHxD) | | | | | |
| Product | 325x1660x380 | | | | | |

❁ 10.217 Top Header Graphic Size: 255x147mm



VERONA 12xA4

made of acrylic and aluminium

INFORMATION

* W: Width H: Height D: Depth * mm

The Verona 12xA4 Brochure Stand with casters is made of aluminium with acrylic shelves. This model has 4 shelves for 12 xA4 format documents, like brochures, journals, periodicals or newspapers. Also it has a top acrylic header for a 730x147mm graphic. This mobile Brochure Stand is ideal for using in highly-populated lobbies, travel agencies, libraries or for waiting rooms to provide reading material to the visiting clients.

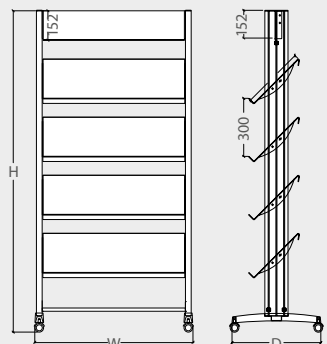

with 12xA4 brochures



brake wheels



VERONA 12xA4

* W: Width H: Height D: Depth * mm

| | QTY | N.W | G.W | C.B.M | Size (WxHxD) |  x2 |
|---------|------------------|--------|--------|--------|--------------|--|
| Packing | 1 | 3kg | 3.95kg | 0.0307 | 420x430x170 | |
| | 1 | 4.45kg | 5kg | 0.0188 | 145x1620x80 | |
| | External (WxHxD) | | | | | |
| Product | 800x1660x380 | | | | | |

❁ 10.218 Top Header Graphic Size: 730x147mm



INFORMATION

* W: Width H: Height D: Depth * mm

The Cañada Brochure Stand is made of aluminium with 4 acrylic shelves for A4 format literature documents, like flyers, magazines or brochures. It features a double-sided large poster holder on one of its sides, so Cañada Brochure Stand is ideal for using in highly-populated lobbies, travel agencies, libraries or for waiting rooms to provide reading material to the visiting clients, also thanks to its LED Light, it's useful for darker halls or movie theaters.

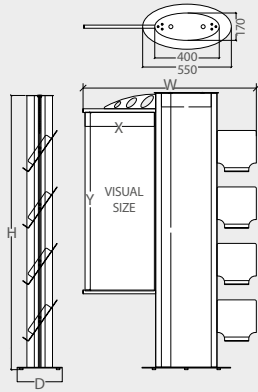

CAÑADA

* W: Width H: Height D: Depth *mm

| | QTY | N.W | G.W | C.B.M | Size (WxHxD) |
|---------------|---|--------------|------------------|--------|---|
| Packing | 1 | 18.5kg | 19.7kg | 0.3752 | 652x345x1740 |
| | | Visual (X-Y) | External (WxHxD) | | |
| Product | Totem: 308x1699 Totem: 430x1109 | | 1074x1700x280 | |  |
| 10.470 | Totem Graphic Size: 324x1700mm Poster Graphic Size: 430x1100mm | | | | |

CAÑADA



double sided



4x A4 holders

made of aluminium and acrylic supports



INFORMATION

* W: Width H: Height D: Depth * mm

The Hito Brochure Stand is made of silver finish aluminium with 3 acrylic shelves for A4 format literature documents, like flyers, magazines or brochures. It features a solid and stable 8 weight steel base and a double-sided large poster holder on one of its sides, so Hito Brochure Stand is ideal for using in highly populated lobbies, travel agencies, libraries or for waiting rooms to provide reading material to the visiting clients.

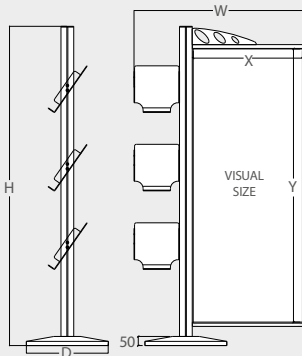

HITO

* W: Width H: Height D: Depth *mm

| | QTY | N.W | G.W | C.B.M | Size (WxHxD) |
|---------------|--------------------------|--------------|------------------|--------|---|
| Packing | 1 | 2.8kg | 3.6kg | 0.0123 | 80x1920x80 |
| | 1 | 8.2kg | 8.5kg | 0.0097 | 440x440x50 |
| | 1 | 1.6kg | 1.9kg | 0.0190 | 390x650x75 |
| | | Visual (X-Y) | External (WxHxD) | | |
| Product | 600x1500 | | 930x1753x450 | |  |
| 10.471 | Graphic Size: 600x1510mm | | | | |

HITO

3x A4 holders

double faced

8 kg steel base

made of aluminium and acrylic supports



- EN Wall-mounted leaflet dispenser. Made of aluminum and acrylic. Capacity 8x A4.
- FR Porte brochures à fixer au mur, fabriqué en aluminium et acrylique. Capacité 8x A4.
- PT Porta-catálogos de parede, fabricado em alumínio e acrílico. Capacidade de 8x A4.
- ES Portafolletos a pared, realizado en aluminio y metacrilato. Con capacidad para 8x A4.



for 8x A4 brochures

made of acrylic and aluminium

ATHY



* W: Width H: Height D: Depth * mm

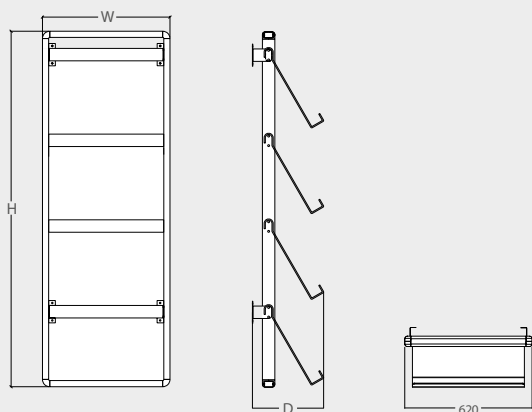

INFORMATION

Athy Brochure Wall Holder has 4 shelves and it is designed to accommodate 2x A4 portrait format documents by shelf. The magazine rack is wall mounting, giving you more floor space while still providing passersby with information. This type of rack system allows you to adjust the literature holders to the size you need. In this manner, it is up and out of your way, while remaining at eye level for your customers. Athy Holder is ideal for an office or lobby. Also see it in waiting rooms to hold your magazines and newspapers, or in information centers, travel bureaus and clinics to hold your brochures.



ATHY * W: Width H: Height D: Depth * mm

| | QTY | N.W | G.W | C.B.M | Size (WxHxD) |
|---------|------------------|--------|--------|--------|--------------|
| Packing | 1 | 11.7kg | 13.4kg | 0.1742 | 185x1500x650 |
| | External (WxHxD) | | | | |
| Product | 620x1450x290 | | | | |

10.988



STEEL BOARDS

| | |
|----|--|
| EN | Double-sided boards, suitable for indoor or outdoor areas of great affluence. Several colors and sizes available. |
| FR | Chevalet double face, appropriés pour les zones intérieures ou extérieures de grande affluence. Plusieurs couleurs et tailles disponibles. |
| PT | Cavaletes de dupla face. Ideal para áreas com grande afluência, tanto interiores como exteriores. Várias cores e tamanhas disponíveis. |
| ES | Caballetes portagráficas de doble cara. Ideal para áreas de gran afluencia en exterior o interior. Varios colores y tamaños disponibles. |

INFORMATION

* W: Width H: Height D: Depth * mm

Kerry Double-sided Frame is made of durable lacquered galvanized steel, ensuring years of durability and functionality, available in 3 colors. Designed for indoor and outdoor use. The non-glare protective cover (included) attaches easily using magnets. Ideal to advertise home sales, open houses, restaurant specials, store sales or promotional services.

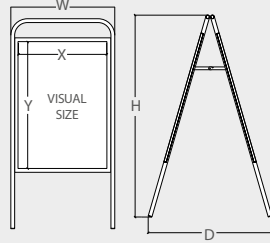

KERRY H700

* W: Width H: Height D: Depth *mm

| | QTY | N.W | G.W | C.B.M | Size (WxHxD) |
|---------------|--|--------------|-------------------------|--------|--------------|
| Packing | 1 | 11.8kg | 12.7kg | 0.0504 | 575x80x1095 |
| | Visual (X-Y) | | External (WxHxD) | | |
| Product | 462x662 | 544x1056x647 | | | |
| 10.691 | <input type="checkbox"/> <input type="checkbox"/> <input type="checkbox"/> | | Graphic Size: 500x700mm | | |

KERRY H1000

* W: Width H: Height D: Depth *mm

| | QTY | N.W | G.W | C.B.M | Size (WxHxD) |
|---------------|--|--------------|--------------------------|--------|--------------|
| Packing | 1 | 16.35kg | 17.9kg | 0.0766 | 760x70x1440 |
| | Visual (X-Y) | | External (WxHxD) | | |
| Product | 662x962 | 744x1345x814 | | | |
| 10.692 | <input type="checkbox"/> <input type="checkbox"/> <input type="checkbox"/> | | Graphic Size: 700x1000mm | | |

INFORMATION

* W: Width H: Height D: Depth * mm

Cork Double-sided Frame is made of durable lacquered galvanized steel available in 3 colors. Designed for indoor and outdoor use. Also it features a top header area. The non-glare protective cover (included) attaches easily using magnets. The Cork Board is ideal to advertise home sales, open houses, restaurant menu specials, store sales or promotional services.

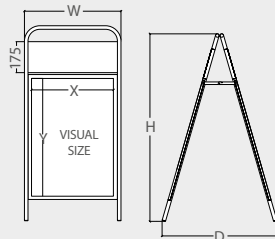

CORK H700

* W: Width H: Height D: Depth *mm

| | QTY | N.W | G.W | C.B.M | Size (WxHxD) |
|---------------|--|--------------|---|--------|--------------|
| Packing | 1 | 11.7kg | 12.7kg | 0.0459 | 460x70x1170 |
| | Visual (X-Y) | | External (WxHxD) | | |
| Product | 462x662 504x175 | 544x1056x647 | | | |
| 10.695 | <input type="checkbox"/> <input type="checkbox"/> <input type="checkbox"/> | | Graphic Size: 500x700mm Top Header Graphic Size: 175x504mm | | |

CORK H1000

* W: Width H: Height D: Depth *mm

| | QTY | N.W | G.W | C.B.M | Size (WxHxD) |
|---------------|--|--------------|--|--------|--------------|
| Packing | 1 | 18.65kg | 20.2kg | 0.0766 | 760x70x1440 |
| | Visual (X-Y) | | External (WxHxD) | | |
| Product | 662x962 704x175 | 744x1345x814 | | | |
| 10.696 | <input type="checkbox"/> <input type="checkbox"/> <input type="checkbox"/> | | Graphic Size: 700x1000mm Top Header Graphic Size: 175x704mm | | |

KERRY



with magnetic protective cover

double sided



lacquered galvanized steel



CORK



with magnetic protective cover

double sided



lacquered galvanized steel



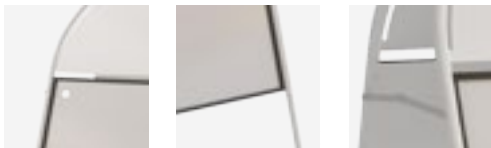

with magnetic protective cover

MONAGHAN



INFORMATION

* W: Width H: Height D: Depth * mm

Monaghan 2-sided board is made of durable lacquered galvanized steel available in 3 colors. Designed for indoor and outdoor use. Also it features a top header for a graphic. The non-glare protective cover (included) attaches easily using magnets. This Board is ideal to advertise home sales, open houses, restaurant menu specials, store sales or promotional services.

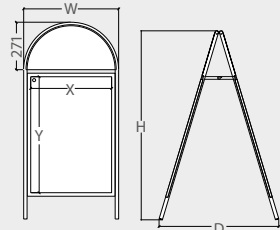

MONAGHAN H700

* W: Width H: Height D: Depth *mm

| | QTY | N.W | G.W | C.B.M | Size (WxHxD) |
|---------|-----------------------|-----------------------|-----------------------|---|--------------|
| Packing | 1 | 11.7kg | 12.7kg | 0.0459 | 560x70x1170 |
| Product | Visual (X-Y) | | External (WxHxD) | | |
| | 462x662 502x250 | | 683x1078x683 | | |
| 10.699 | <input type="radio"/> | <input type="radio"/> | <input type="radio"/> | Graphic Size: 500x700mm Top Header Graphic Size: 514x256mm | |

MONAGHAN H1000

* W: Width H: Height D: Depth *mm

| | QTY | N.W | G.W | C.B.M | Size (WxHxD) |
|---------|-----------------------|-----------------------|-----------------------|--|--------------|
| Packing | 1 | 7.5kg | 8.9kg | 0.0702 | 765x60x1530 |
| Product | Visual (X-Y) | | External (WxHxD) | | |
| | 702x1002 702x361 | | 742x1523x675 | | |
| 10.700 | <input type="radio"/> | <input type="radio"/> | <input type="radio"/> | Graphic Size: 700x1000mm Top Header Graphic Size: 714x357mm | |

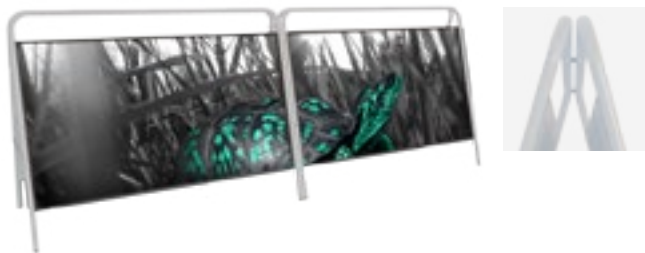

LIFFORD



INFORMATION

* W: Width H: Height D: Depth * mm

Lifford double-sided board is made of durable white lacquered galvanized steel. Designed for both indoor and outdoor. The non-glare protective cover is included and it attaches easily to the front using magnets. This Steel Board is ideal to use together with other(s) Lifford for creating a large billboard to advertise home or restaurant sales, store specials or for promotional services.

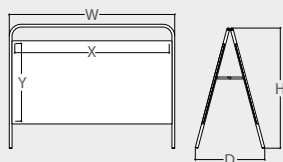

LIFFORD

* W: Width H: Height D: Depth *mm

| | QTY | N.W | G.W | C.B.M | Size (WxHxD) |
|---------|-----------------------|--------------------------|------------------|--------|--------------|
| Packing | 1 | 15.7kg | 17kg | 0.0751 | 935x65x1235 |
| Product | Visual (X-Y) | | External (WxHxD) | | |
| | 1120x564 | | 1200x872x505 | | |
| 10.701 | <input type="radio"/> | Graphic Size: 1156x600mm | | | |

double sided



with magnetic protective cover





OUTDOOR POSTER STAND



whiteboard



EN A-Whiteboard, produced in epoxy painted steel for an extra protection. Can be used with a white board for markers (which is supplied separately).

FR Chevalet. Produit en acier peint époxy pour une protection supplémentaire. Peut être utilisé avec un tableau blanc pour marqueurs (fourni séparément).

PT Cavalete pintado com epóxi para uma proteção extra. Pode ser usado com um painel branco (vendido por separado)

ES Caballete fabricado en acero pintado al epoxi para mayor protección. Se puede colocar una pizarra blanca para rotuladores que se suministra aparte.

INFORMATION

* W: Width H: Height D: Depth * mm

The Outdoor Poster Stand is made of durable Epoxy painted Steel. Featuring 6 colors available and the possibility of being used with a whiteboard (sold separately | 10.168) for markers. This Outdoor A-frame can be seen from both sides when placing on a sidewalk for maximum viewers. Ideal to advertise home sales, open houses, restaurant specials, store sales or promotional services. To change out signs, just slide the poster through the steel holders.

OUTDOOR POSTER STAND

* W: Width H: Height D: Depth *mm

| | QTY | N.W | G.W | C.B.M | Size (WxHxD) | | |
|---------------|--------------|-----|-------|--------|--------------|--|--------------------------|
| Packing | 1 | 6kg | 6.7kg | 0.0523 | 1200x65x670 | | |
| | Visual (X-Y) | | | | | | |
| Product | 600x1000 | | | | | | |
| 10.167 | | | | | | | Graphic Size: 600x1000mm |

WHITEBOARD

* W: Width H: Height D: Depth *mm

| | QTY | N.W | G.W | C.B.M | Size (WxHxD) | |
|---------------|-----|-----------------------|-----|--------|--------------|--|
| Packing | 1 | 1kg | 1kg | 0.0523 | 1200x65x670 | |
| 10.168 | | Whiteboard: 590x995mm | | | | |



REF 13.129



REF 13.130

DOVER

3 different models available



REF 13.131

DOVER

* W: Width H: Height D: Depth *mm

| | QTY | N.W | G.W | C.B.M | Size (WxHxD) |
|---------------|-------------------------|-------|----------------------------|--------|------------------|
| Packing | 1 | 1.4kg | 2kg | 0.0258 | 525x55x895 |
| | Visual (X-Y) 13.129 | | Visual (X-Y) 13.130 13.131 | | External (WxHxD) |
| Product | 480x715 | | 480x815 | | 500x820x665 |
| 13.129 | Graphic Size: 480x715mm | | | | |
| 13.130 | Graphic Size: 480x815mm | | | | |
| 13.131 | Blackboard: 480x815mm | | | | |

INFORMATION

* W: Width H: Height D: Depth * mm

The double-sided Dover A-Board features 3 different models, the first one comes with handle for an easy transportation, second one features all along customizable front for a great visual impact and the third model features a Blackboard in front of both sides, ideal when placing on a sidewalk for maximum viewers.

