



iviceversa
Soluciones
Gráficas

TENSION TEXTILE DISPLAY	190
TENSION TEXTILE ACCESSORIES	215
HANGING SIGNS	216
ROTATING STAND	219
EXHIBITION ITEMS	220
PROFILE STAND	228
GLASS WALL	229
ALUMINIUM TRUSS	230
FLOOR SYSTEM	234
EXHIBITION FURNITURE	236



EN Economic display system with great visual impact. It uses a printed graph that by the own textile tension gets adjusted to the aluminium structure. Quick and easy assembly.

FR Système displays économique qui a un grand impact visuel. L'impression textile s'ajuste à la structure d'aluminium par tension. Housse de transport inclus. Facile et rapide à monter.

PT Expositor económico que causa um grande impacto visual. Utiliza uma impressão em tecido que se adapta à estrutura em alumínio mediante tensão. É fácil e rápido de montar.

ES Sistema de display económico con gran impacto visual. Emplea una gráfica impresa en textil que mediante la tensión propia del tejido se ajusta a la estructura de aluminio. Fácil y rápido montaje.

KANO 3x3



optional spotlight
- sold apart -



easy to assemble



*Printed on textile.
Impression sur toile.
Impressão em tecido.
Impresión en tela.

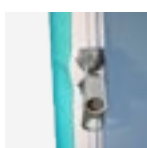
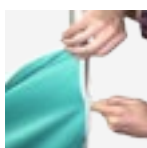
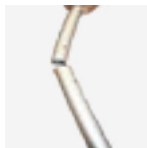

carry bag included

INFORMATION

This Tension Display features a 3x3 ratio, with a curved lightweight aluminum frame that assembles in a few minutes. A padded canvas carrying bag included for an easy storage and transportation. Denote your stand or photocall with the innovative design and versatility of textile printing. Ideal as a divider for a meeting or as a stand-alone photocall for advertisements and promotions.

KANO	QTY	N.W	G.W	C.B.M	SIZE
Packing	1	10.7kg	12.2kg	0.0284	240x160x740mm
✳ 15.220	Graphic Size: 2600x2300mm				

* Custom textile printing in full color is available but not included.

EXTERNAL SIZE

ARTWORK

*mm

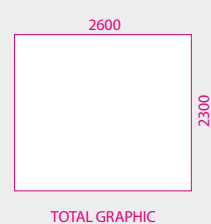
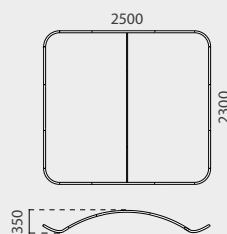

TOTAL GRAPHIC

ZARIA 4x3



optional spotlight
- sold apart -



*Printed on textile.
Impression sur toile.
Impressão em tecido.
Impresión en tela.



INFORMATION

This Tension Display features a 4x3 ratio, with a curved lightweight aluminum frame that assembles in a few minutes. A padded canvas carrying bag included for an easy storage and transportation. Denote your stand or photocall with the innovative design and versatility of textile printing. Ideal as a divider for a meeting or as a stand-alone photocall for advertisements and promotions.

ZARIA	QTY	N.W	G.W	C.B.M	SIZE
Packing	1	12.7kg	14.2kg	0.0343	290x160x740mm
 15.221	Graphic Size: 3070x2300mm				

* Custom textile printing in full color is available but not included.

EXTERNAL SIZE

ARTWORK

*mm

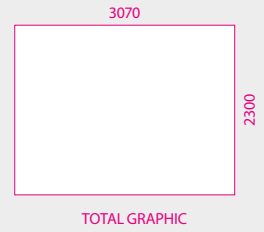
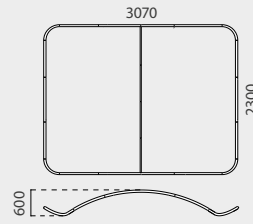

BAMAKO 7x3



optional spotlight
- sold apart -



*Printed on textile.
Impression sur toile.
Impressão em tecido.
Impresión en tela.



INFORMATION

This Tension Display features a 7x3 ratio, with a curved lightweight aluminum frame that assembles in a few minutes. A padded canvas carrying bag included for an easy storage and transportation. Denote your stand or photocall with the innovative design and versatility of textile printing. Ideal as a divider for a meeting or as a stand-alone photocall for advertisements and promotions.

BAMAKO	QTY	N.W	G.W	C.B.M	SIZE
Packing	1	17.1kg	18.6kg	0.046	390x160x740mm
 15.222	Graphic Size: 5280x2300mm				

* Custom textile printing in full color is available but not included.

EXTERNAL SIZE

ARTWORK

*mm

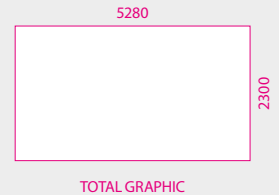
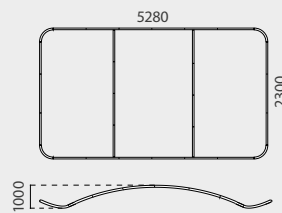



i optional spotlight - sold apart -

KAYES 2x3



*Printed on textile.
Impression sur toile.
Impressão em tecido.
Impresión en tela.

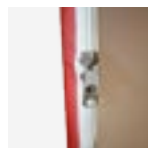
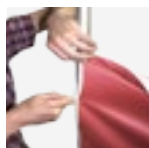
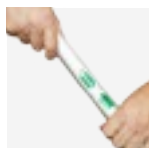

EXTERNAL SIZE

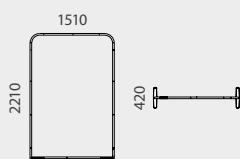

ARTWORK

*mm

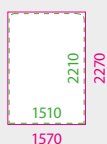

SAFE ZONE
TOTAL GRAPHIC

EXTERNAL SIZE

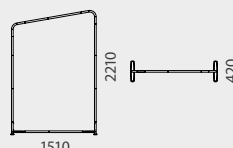

ARTWORK

*mm

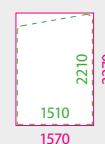

SAFE ZONE
TOTAL GRAPHIC

INFORMATION

Kayes features a 2x3 ratio, with a lightweight aluminum frame that assembles quickly. Carrying bag is included for an easy storage and transportation. 2 shapes available. Denote your stand or photocall with the innovative design and versatility of textile printing. Ideal as a divider or as photocall for advertisements and promotions.

KAYES1	QTY	N.W	G.W	C.B.M	SIZE
Packing	1	15.1kg	17.6kg	0.022	190x160x740mm
* 15.223	Graphic Size: 1570x2270mm				

* Custom textile printing in full color is available but not included.

KAYES2	QTY	N.W	G.W	C.B.M	SIZE
Packing	1	15.1kg	17.6kg	0.022	190x160x740mm
* 15.233	Graphic Size: 1570x2270mm				

* Custom textile printing in full color is available but not included.

lightweight aluminium structure



*Printed on textile.
Impression sur toile.
Impressão em tecido.
Impresión en tela.

BILMA 3x3

i optional spotlight - sold apart -

EXTERNAL SIZE

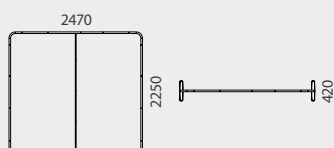

ARTWORK

*mm

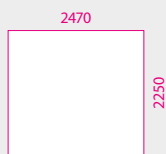

TOTAL GRAPHIC

INFORMATION

Bilma features a 3x3 ratio, with a straight lightweight aluminum frame. Carrying bag is included for an easy storage and transportation. Denote your stand or photocall with the innovative design and versatility of textile printing. Ideal as a divider or as a photocall for advertisements and promotions.

BILMA	QTY	N.W	G.W	C.B.M	SIZE
Packing	1	17.1kg	18.6kg	0.028	240x160x740mm
* 15.224	Graphic Size: 2470x2250mm				

* Custom textile printing in full color is available but not included.



NIAMEY 4x3

 optional spotlight - sold apart -



*Printed on textile.
Impression sur toile.
Impressão em tecido.
Impresión en tela.

INFORMATION

Niamey features a 4x3 ratio, with a straight lightweight aluminum frame. Carrying bag is included for an easy storage and transportation. Denote your stand or photocall with the innovative design and versatility of textile printing. Ideal as a divider or as a photocall for advertisements and promotions.

NIAMEY	QTY	N.W	G.W	C.B.M	SIZE
Packing	1	12.7kg	14.2kg	0.034	290x160x740mm
 15.225	Graphic Size: 2950x2250mm				

* Custom textile printing in full color is available but not included.

EXTERNAL SIZE

ARTWORK

*mm

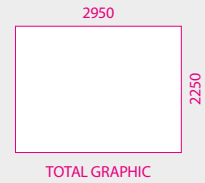
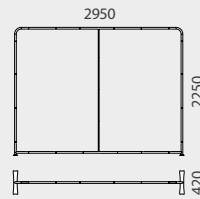

TOTAL GRAPHIC

 optional spotlight - sold apart -

easy to assemble



*Printed on textile.
Impression sur toile.
Impressão em tecido.
Impresión en tela.

INFORMATION

Dakar features a large 7x3 ratio, with a straight lightweight aluminum frame. The graphic textile set attaches with a zipper underneath the frame for a seamless appearance. A canvas bag is included for an easy transportation. Denote your stand with the innovative design and versatility of the textile printing. Great for using at a trade show or at any media event.

DAKAR	QTY	N.W	G.W	C.B.M	SIZE
Packing	1	17.10kg	18.60kg	0.046	390x160x740mm
 15.226	Graphic Size: 5830x2250mm				

* Custom textile printing in full color is available but not included.

EXTERNAL SIZE

ARTWORK

*mm

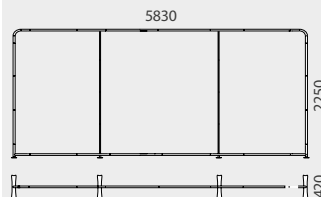

TOTAL GRAPHIC



ZAMBIA



13.450

i optional spotlight
- sold apart -

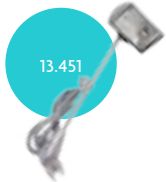

13.451

denote your
stand or photocall

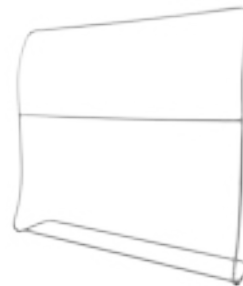

*Printed on textile.
Impression sur toile.
Impressão em tecido.
Impresión en tela.



INFORMATION

Zambia display features a lightweight aluminum frame that assembles in minutes. The graphic textile set attaches with a zipper underneath the frame for a seamless appearance. A canvas bag is included for an easy transportation. Denote your stand or photocall with the innovative design and versatility of the textile printing. Great for using at trade shows or at any media event.

EXTERNAL SIZE

ARTWORK

*mm

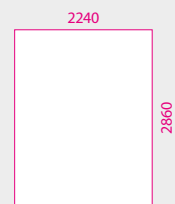
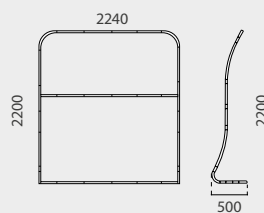

TOTAL GRAPHIC

ZAMBIA	QTY	N.W	G.W	C.B.M	SIZE
Packing	1	9.25kg	10.1kg	0.0463	310x180x830mm
15.219	Graphic Size: 2240x2860mm				

* Custom textile printing in full color is available but not included.

NAMIBIA

 optional spotlight - sold apart -



ideal for a meeting point

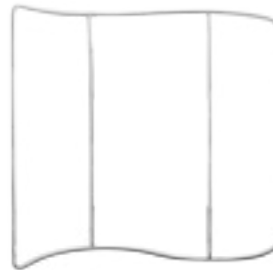

*Printed on textile.
Impression sur toile.
Impressão em tecido.
Impresión en tela.



INFORMATION

Namibia display features a curved lightweight aluminum frame. A padded canvas carrying bag included for an easy storage and transportation. Denote your stand or tradebooth with the innovative design and versatility of textile printing. Ideal as a divider for a meeting or as a stand-alone photocall for advertisements and promotions at tradeshows or at any media event.

EXTERNAL SIZE

ARTWORK

*mm

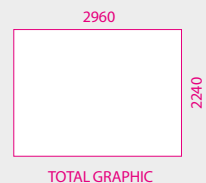
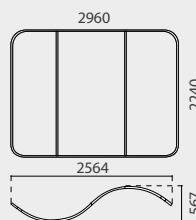

TOTAL GRAPHIC

NAMIBIA	QTY	N.W	G.W	C.B.M	SIZE
Packing	1	9.4kg	10.3kg	0.0463	310x180x830mm
 15.218	Graphic Size: 2960x2240mm				

* Custom textile printing in full color is available but not included.

BANGUI

 optional spotlight
- sold apart -



 *Printed on textile.
Impression sur toile.
Impressão em tecido.
Impresión en tela.

INFORMATION

The Bangui display features a curved lightweight aluminum frame. Also a padded canvas carrying bag is included for an easy storage and transportation. Denote your tradebooth with the two useful wooden shelves included and the innovative design and versatility of textile printing. Great for using at trade shows or at any media event.

EXTERNAL SIZE

ARTWORK

*mm

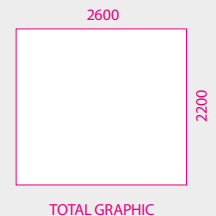
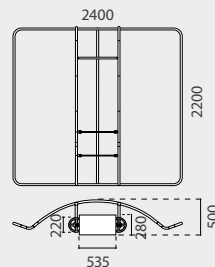

TOTAL GRAPHIC

BANGUI	QTY	N.W	G.W	C.B.M	SIZE
Packing	1	15.95kg	16.90kg	0.0772	470x155x1060mm
 15.215	Graphic Size: 2600x2200mm				

* Custom textile printing in full color is available but not included.

KENIA

 optional spotlight
- sold apart -



 *Printed on textile.
Impression sur toile.
Impressão em tecido.
Impresión en tela.

INFORMATION

Kenia display features a straight lightweight aluminum frame. A padded canvas carrying bag is included. The graphic textile set attaches with a zipper underneath the frame for a seamless appearance. Denote your stand with the safety holder for tablet and the three useful wooden shelves included. Ideal as a divider for a meeting, advertisements and promotions.

EXTERNAL SIZE

ARTWORK

*mm

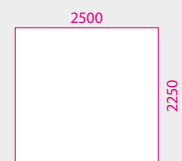
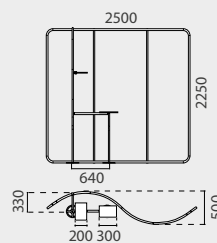

TOTAL GRAPHIC

KENIA	QTY	N.W	G.W	C.B.M	SIZE
Packing	1	16.55kg	17.65kg	0.0772	470x155x1060mm
 15.213	Graphic Size: 2500x2250mm				

* Custom textile printing in full color is available but not included.

MALI



i optional spotlight
- sold apart -



Safety Holder for
Tablet 244x184mm

* tablet not included

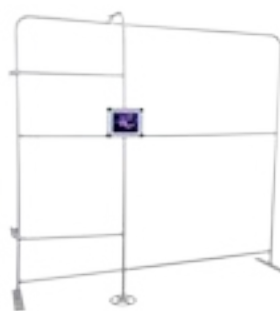
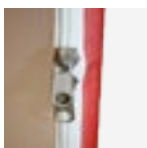
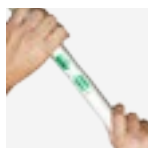
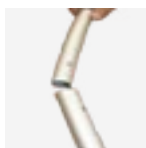

*Printed on textile.
Impression sur toile.
Impressão em tecido.
Impresión en tela.

INFORMATION

Mali tension display features a straight lightweight aluminum frame. A padded canvas carrying bag included for an easy storage and transportation. Denote your stand with the safety holder for tablet included and the innovative design and versatility of textile printing. Ideal as a divider for a meeting, advertisements and promotions.

MALI	QTY	N.W	G.W	C.B.M	SIZE
Packing	1	13.85kg	14.95kg	0.0772	470x155x1060mm
15.214		Graphic Size: 2470x2225mm			

* Custom textile printing in full color is available but not included.

EXTERNAL SIZE

ARTWORK

*mm

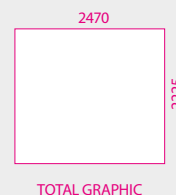
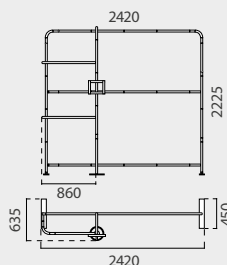

TOTAL GRAPHIC

BURKINA



13.450



13.451

i optional spotlight
- sold apart -



Safety Holder for
Tablet 244x184mm

* tablet not included



*Printed on textile.
Impression sur toile.
Impressão em tecido.
Impresión en tela.

INFORMATION

Burkina display features a straight lightweight aluminum frame. A padded canvas carrying bag included for an easy storage and transportation. Denote your stand with the safety holder for tablet and the two useful wooden shelves included. Ideal for using as a divider for a meetin or as a photocall for advertisements and promotions at trade shows or at any media event.

BURKINA	QTY	N.W	G.W	C.B.M	SIZE
Packing	1	15.90kg	16.10kg	0.0772	470x155x1060mm
15.216	Graphic Size: 1400x2200mm				

* Custom textile printing in full color is available but not included.

EXTERNAL SIZE

ARTWORK

*mm

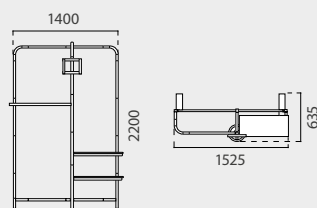

TOTAL GRAPHIC



ITACA WALL ROOM



ideal as a meeting point



*Printed on textile.
Impressão sur toile.
Impressão em tecido.
Impresión en tela.



optional spotlight (sold apart)

13.450

13.451

INFORMATION

Itaca display features a lightweight aluminum wall that assembles in minutes. The graphic textile set attaches with a zipper underneath the frame for a seamless appearance. A canvas bag is included for an easy transportation. Denote your stand or photocall with the innovative design and versatility of the textile printing. Great for using at trade shows or at any media event., this event fixture features enough space for setting up counters, chairs or any display and create a conference environment for your bussines. Ideal for meeting one-on-one with potential customers at a trade show.

ITACA	QTY	N.W	G.W	C.B.M	SIZE
Packing	1	9.5kg	10kg	0.09	1100x300x300mm
* 15.255	Graphic Size: 4890x1950mm				

* Custom textile printing in full color is available but not included.

EXTERNAL SIZE

ARTWORK

*mm



1950

4890

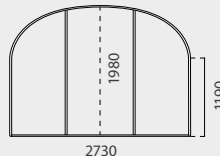

1190

SAFE ZONE
TOTAL GRAPHIC



EXTERNAL SIZE

ARTWORK

*mm

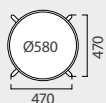

SAFE ZONE
TOTAL GRAPHIC

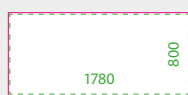

1810



INFORMATION

The Delfos table features a Ø580mm wooden surface with a lightweight aluminum structure that assembles in minutes. The graphic textile set attaches with a zipper underneath the frame for a seamless appearance. A canvas bag is included. Ideal for being used with Itaca Wall.

DELFO	QTY	N.W	G.W	C.B.M	SIZE
Packing	1	6.6kg	7kg	0.0544	800x100x680mm
* 15.257	Graphic Size: 1810x830mm				

* Custom textile printing in full color is available but not included.

DELFO



NEW



fast to set-up

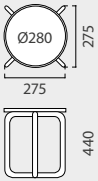
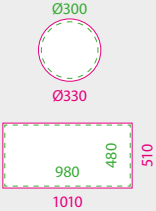

*Printed on textile.
Impressão sur toile.
Impressão em tecido.
Impresión en tela.

EXTERNAL SIZE	ARTWORK	*mm
		
<p>SAFE ZONE TOTAL GRAPHIC</p>		

INFORMATION

The Tebas Chair features a Ø280mm wooden surface with a lightweight aluminum 440mm high structure that assembles in a few minutes. The graphic textile set attaches with a zipper. A canvas bag is included. Ideal for being used with Itaca Wall and Delfos Table.

TEBAS	QTY	N.W	G.W	C.B.M	SIZE
Packing	1	2.5kg	3kg	0.018	450x100x400mm
 15.256	Graphic Size: 1010x510mm				

* Custom textile printing in full color is available but not included.

TEBAS CHAIR



 *Printed on textile.
Impression sur toile.
Impressão em tecido.
Impresión en tela.





ALUMINIUM TUBULAR SYSTEM

NEW

 *Printed on textile.
Impression sur toile.
Impressão em tecido.
Impresión en tela.

INFORMATION

*mm

This pack of 4 aluminium tubes for tubular system has Ø28mm diameter, it has 1mm of thickness and 3m length. The bars do not bring the holes made, so that the client can determine where to place them. Each pack comes with instructions included. Set up your own aluminum structure using these aluminum tubes with the connecting pieces of the tubular system. Ideal for tradeshows, media events or expositions.



ALUMINIUM TUBE Ø28 FOR TUBULAR SYSTEM



15.258

 4 Uni. x 3000mm

CORNER CONNECTION FOR TUBULAR SYSTEM

"T" CONNECTION FOR TUBULAR SYSTEM

CLIP STRIP FOR TUBULAR SYSTEM



INFORMATION

*mm

This Corner connection piece is made of polycarbonate and it fits with aluminium tubes by the click system. Clip Strips are included.

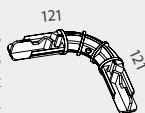

INFORMATION

*mm

This "T" shape connection piece is made of polycarbonate and it fits with aluminium tubes by the click system. Clip Strips are included.

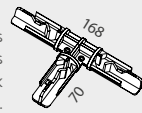

INFORMATION

*mm

Pack of 10 plastic Clip Strip. This clip fits in tubular connections for the click system.

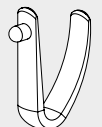

15.259

x4 

15.260

x2 

15.261

x10 

ALUMINIUM TUBULAR SYSTEM EXAMPLES



SET-UP INFORMATION

The multi-function Tubular System is designed to support several configurations applied by the customer, such as turning it into a Display Totem, a Barrier Banner or a Stand by using tension textil, panels or incorporating bases. Easy to assemble, each piece is designed for quick installation and use. Featuring 3m aluminum tubes without drilling for user's personalization (sold in pack of 4 units), Corner and "T" connections for setting-up structures and Clip Strips for connecting easily the aluminum tubes with corners and "Ts". Denote your stand or tradebooth with your own customizable display or stand. Ideal for setting-up dividers for a meeting or as a stand-alone photocal for advertisements and promotions at tradeshows or at any media event so is a practical display case that will look great in markets, shops, exhibition events or stores.



DISPLAY APPLICATIONS

* Custom textile printing in full color is available but not included.

Fasteners sold apart, see accessories

same structure, different functionality

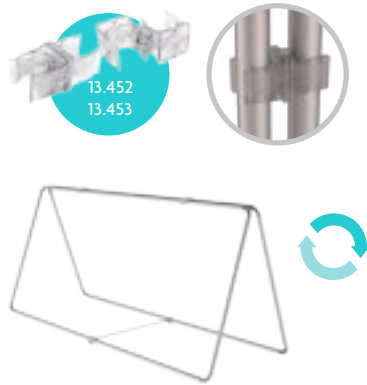
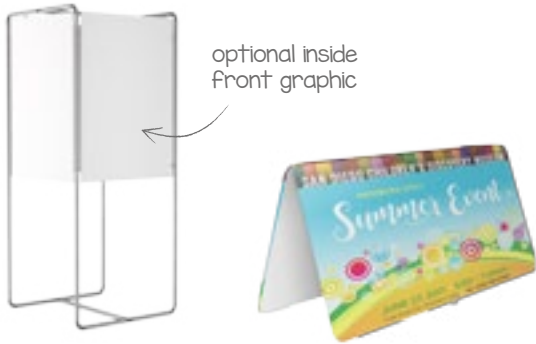

STAND APPLICATIONS

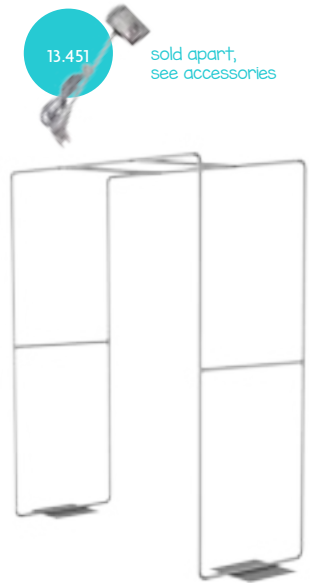

* Customization possibilities are orientative ideas, in no case are supplied with the display / * Les possible personnalisation sont à titre indicatif mais ne sont pas incluses dans le display.
 * As possibilidades de personalização são orientativas, em nenhum caso são fornecidas com o artigo./ * Las posibilidades de personalización son orientativas, en ningún caso se suministran con el display.



i optional spotlight
- sold apart -



EXTERNAL SIZE

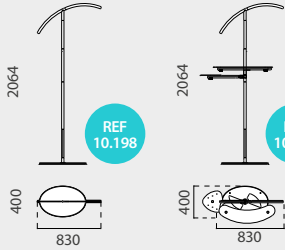

ARTWORK

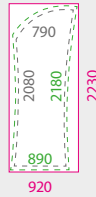

FRONT VIEW
SAFE ZONE
TOTAL GRAPHIC



INFORMATION

Aluminium Tension Textile Display stand with upper curved design. Teguise is an excellent addition to any tradeshow configuration. Available with shelves.

TEGUISE	QTY	N.W	G.W	C.B.M	SIZE
Packing	1	4.9kg	5.32kg	0.04	430x120x610mm
10.198	Graphic Size: 920x2230mm				

TEGUISE.S.	QTY	N.W	G.W	C.B.M	SIZE
Packing	1	4.9kg	5.32kg	0.04	430x120x610mm
10.199	1	2.2kg	2.57kg	0.02	280x60x730mm
Graphic Size: 920x2230mm					* with shelves

* Custom textile printing in full color is available but not included.

TEGUISE

available with
or without
shelves



*Printed on textile.
Impression sur toile.
Impressão em tecido.
Impresión en tela.

i optional spotlight
- sold apart -



EXTERNAL SIZE

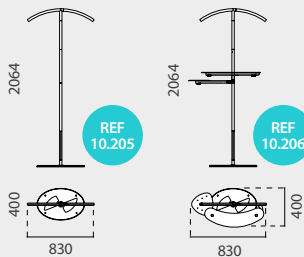

ARTWORK

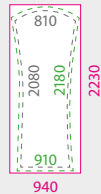

FRONT VIEW
SAFE ZONE
TOTAL GRAPHIC



INFORMATION

Aluminium Tension Textile Display stand with upper curved design. Arona is an excellent addition to any tradeshow configuration. Available with shelves.

ARONA	QTY	N.W	G.W	C.B.M	SIZE
Packing	1	4.9kg	5.32kg	0.04	430x120x610mm
10.205	Graphic Size: 940x2230mm				

ARONA.S.	QTY	N.W	G.W	C.B.M	SIZE
Packing	1	4.9kg	5.32kg	0.04	430x120x610mm
10.206	1	2.2kg	2.57kg	0.02	280x60x730mm
Graphic Size: 940x2230mm					* with shelves

* Custom textile printing in full color is available but not included.

ARONA

available with or
without shelves



*Printed on textile.
Impression sur toile.
Impressão em tecido.
Impresión en tela.

MAPUKO



INFORMATION

Mapuko display features a straight lightweight aluminum frame. It features 2 exhibition modes available. Carrying bag is included. This 2-sided textile banner stand is an excellent upgrade to any trade show booth or event promotion.

MAPUKO	QTY	N.W	G.W	C.B.M	SIZE
Packing	1	3.95kg	4.45kg	0.0285	240x125x950mm
 15.217		800x1815mm		700x1700mm	

* Custom textile printing in full color is available but not included.

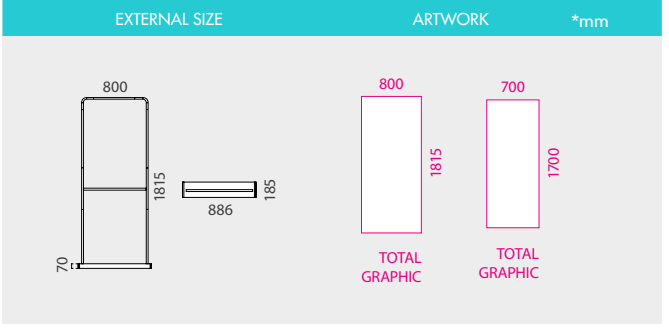

THERA

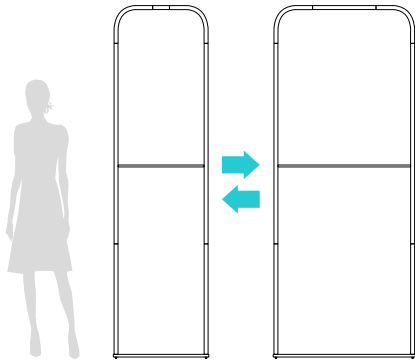

Fasteners available
(see accessories)



carry bag
included



*Printed on textile.
Impression sur toile.
Impresão em tecido.
Impresión en tela.

EXTERNAL SIZES & DOWNLOADABLES ARTWORKS (QR CODE)

*mm

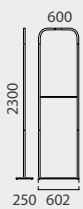

SAFE ZONE
TOTAL GRAPHIC

REF
15.245

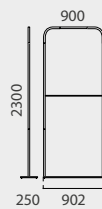

SAFE ZONE
TOTAL GRAPHIC

REF
15.246

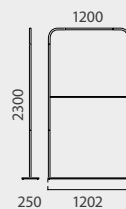

SAFE ZONE
TOTAL GRAPHIC

REF
15.247

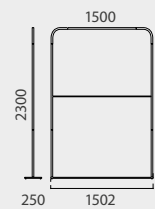



SAFE ZONE
TOTAL GRAPHIC

REF
15.248



INFORMATION

THERA features a linkable lightweight aluminum frame with stable base that assembles quickly. Carrying bag is included. Four widths available. Denote your stand or photocall with the innovative design and versatility of textile printing. Ideal as a divider or stand-alone photocall for advertisements and promotions.

THERA 60	QTY	N.W	G.W	C.B.M	SIZE
Packing	1	6.5kg	8.0kg	0.023	280x105x800mm
 15.245	Graphic Size: 630x2280mm				
THERA 90	QTY	N.W	G.W	C.B.M	SIZE
Packing	1	8.5kg	10kg	0.027	280x105x950mm
 15.246	Graphic Size: 930x2280mm				

THERA 120	QTY	N.W	G.W	C.B.M	SIZE
Packing	1	10.5kg	12.0kg	0.036	280x105x1250mm
 15.247	Graphic Size: 1230x2280mm				
THERA 150	QTY	N.W	G.W	C.B.M	SIZE
Packing	1	12.5kg	14kg	0.045	280x105x1550mm
 15.248	Graphic Size: 1530x2280mm				

* Custom textile printing in full color is available but not included.

* Custom textile printing in full color is available but not included.

BOARD



lightweight



easy assembly



*Printed on textile.
Impression sur toile.
Impressão em tecido.
Impresión en tela.



INFORMATION

Board display features a curved lightweight aluminum frame that assembles in a few minutes. The graphic textile set attaches with a zipper underneath the frame for a seamless appearance. Carrying bag is included for an easy storage and transportation. Denote your stand with the innovative design and versatility of textile printing. Ideal for trade shows or promotional events.

BOARD	QTY	N.W	G.W	C.B.M	SIZE
Packing	1	4.10kg	4.75kg	0.07	800x260x320mm
✳ 15.236		Graphic Size: 530x2550mm			

* Custom textile printing in full color is available but not included.

EXTERNAL SIZE

ARTWORK

*mm

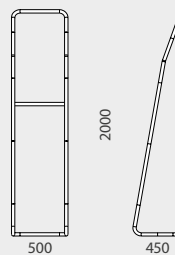

FRONT VIEW
SAFE ZONE
TOTAL GRAPHIC

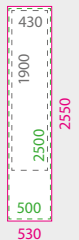

SNAKE



quick assembly



*Printed on textile.
Impression sur toile.
Impressão em tecido.
Impresión en tela.



INFORMATION

Snake display features a curved lightweight aluminum frame that assembles in a few minutes. The graphic textile set attaches with a zipper underneath the frame for a seamless appearance. Carrying bag is included for an easy storage and transportation. Denote your stand with the innovative design and versatility of textile printing. Ideal for trade shows or promotional events.

SNAKE	QTY	N.W	G.W	C.B.M	SIZE
Packing	1	5kg	5.75kg	0.05	650x180x430mm

15.234

Graphic Size: 930x3190mm

* Custom textile printing in full color is available but not included.

EXTERNAL SIZE

ARTWORK

*mm

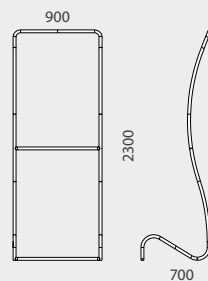

FRONT VIEW
SAFE ZONE
TOTAL GRAPHIC

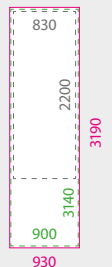

COBRA



Fast and simple set-up



*Printed on textile.
Impression sur toile.
Impressão em tecido.
Impresión en tela.



INFORMATION

Cobra display features a curved lightweight aluminum frame that assembles in a few minutes. The graphic textile set attaches with a zipper underneath the frame for a seamless appearance. Carrying bag is included for an easy storage and transportation. Denote your stand with the innovative design and versatility of textile printing. Ideal for trade shows or promotional events.

COBRA	QTY	N.W	G.W	C.B.M	SIZE
Packing	1	4.9kg	5.7kg	0.05	650x180x430mm

✿ 15.235	Graphic Size: 930x2750mm
----------	--------------------------

* Custom textile printing in full color is available but not included.

EXTERNAL SIZE

ARTWORK

*mm

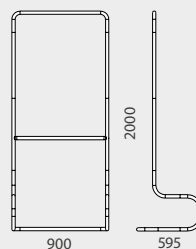

FRONT VIEW
SAFE ZONE
TOTAL GRAPHIC

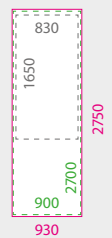

LEAF



great visual impact

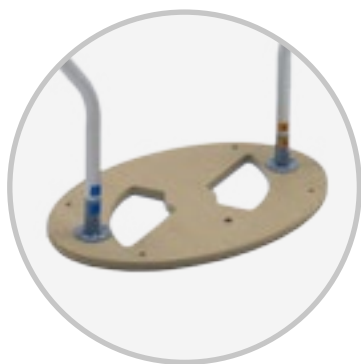

sturdy wooden base



*Printed on textile.
Impression sur toile.
Impressão em tecido.
Impresión en tela.

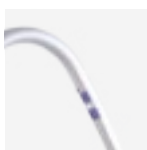
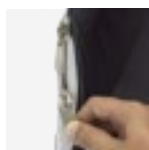

INFORMATION

This display features a leaf shape aluminum frame that assembles in a few minutes. The graphic textile set attaches with a zipper underneath the frame for a seamless appearance. Carrying bag is included for an easy storage and transportation. Denote your stand with the innovative design and versatility of textile printing. Ideal for trade shows or promotional events.

LEAF	QTY	N.W	G.W	C.B.M	SIZE
Packing	1	4.70kg	5.3kg	0.07	1150x140x430mm
* 15.237		Graphic Size: 960x2090mm			

* Custom textile printing in full color is available but not included.

EXTERNAL SIZE

ARTWORK

*mm

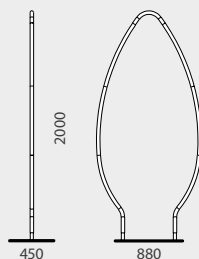

FRONT VIEW
SAFE ZONE
TOTAL GRAPHIC

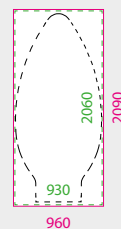

TENSION TEXTILE DISPLAY | Tension Counters

EN Counters for textile printing. Aluminium structure.

FR Comptoir pour toile tendue. Structure en aluminium.

PT Balcão para colocação de tecido. Estrutura em alumínio.

ES Mostradores para impresión textil. Estructura de aluminio.



*Printed on textile.
Impression sur toile.
Impressão em tecido.
Impresión en tela.



BARACOA



carry bag included



INFORMATION

These Counters are designed for using with textile wrap (printed on textile) making it lightweight and easy to fold. Also, the Textile Counters are also simple to setup. All the aluminium poles fit together and snap into place. Simply stretch the wrap over the completed base and it's ready to use. With carry bag for easy traveling. Features a double zip to the interior of the counter for storing, so your exhibition always appears clean and organized. Baracoa is ideal as a lectern or podium at tradeshow, promotional events or conventions and are great to pair with Pop Up banners or any stand.

EXTERNAL SIZE

ARTWORK

*mm

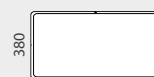
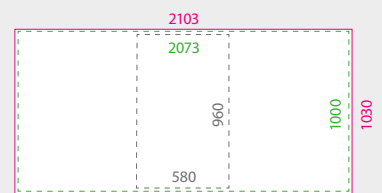
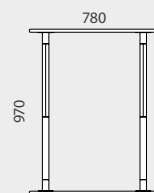

FRONT VIEW
SAFE ZONE
TOTAL GRAPHIC



BARACOA	QTY	N.W	G.W	C.B.M	SIZE
Packing	1	8kg	9.2kg	0.042	860x120x410mm
 13.740	Graphic Size: 2103x1030mm				

* Custom textile printing in full color is available but not included.

oval shape



EXTERNAL SIZE *mm ARTWORK DOWNLOAD

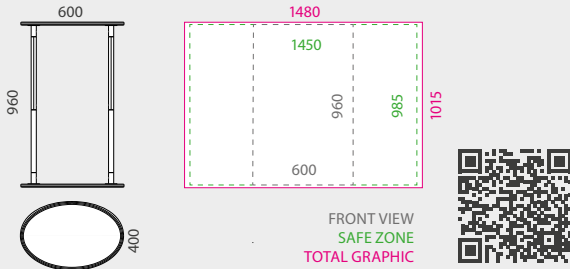

INFORMATION

Manacor is lightweight and fast to setup. Features an oval shape design that allows the advantage of being more accessible than others. With carry bag and a double zip to the interior for storing. Ideal as a lectern or podium at tradeshows, promotional events or great to pair with Pop Ups or any stand.

MANACOR	QTY	N.W	G.W	C.B.M	SIZE
Packing	1	7kg	7.44kg	0.0366	440x130x640mm
10.318	Graphic Size: 1480x1015mm				

* Custom textile printing in full color is available but not included.

MANACOR

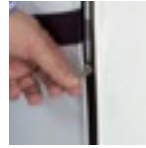
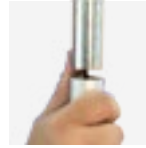
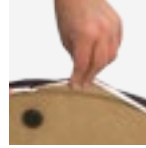

*Printed on textile.
Impression sur toile.
Impressão em tecido.
Impresión en tela.

raindrop shape



EXTERNAL SIZE *mm ARTWORK DOWNLOAD

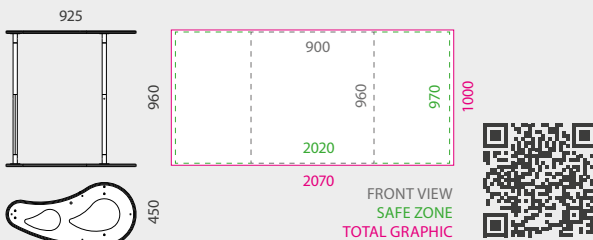

INFORMATION

Mahon is lightweight and easy to assembly. Features the classic raindrop shape design. With carry bag and a double zip to the interior for storing. Mahon is a counter widely used at promotional events, tradeshows, point of sales, so is ideal as a lectern or podium or great to pair with Pop Ups or any stand.

MAHON	QTY	N.W	G.W	C.B.M	SIZE
Packing	1	10.5kg	10.93kg	0.0672	500x140x960mm
10.319	Graphic Size: 2070x1000mm				

* Custom textile printing in full color is available but not included.

MAHON



*Printed on textile.
Impression sur toile.
Impressão em tecido.
Impresión en tela.

3 points of view



EXTERNAL SIZE *mm ARTWORK DOWNLOAD

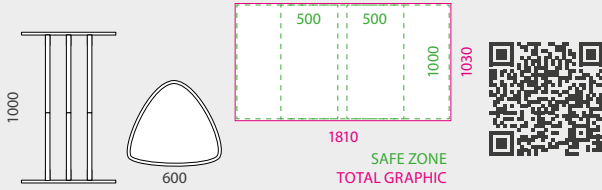

INFORMATION

Creta is lightweight and easy to fold and setup. With carry bag and a single zip to the interior for storing. Features 3 points of view, so this Counter is ideal as a lectern or podium at tradeshows, promotional events or conventions and are great to pair with Pop Up banners or any stand.

CRETA	QTY	N.W	G.W	C.B.M	SIZE
Packing	1	7kg	8.2kg	0.03721	610x100x610mm
10.311	Graphic Size: 1810x1030mm				

CRETA

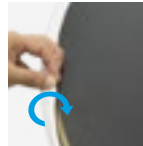

*Printed on fabric.
Impression sur toile.
Impressão em tecido.
Impresión en tela.

hard case



slightly push down

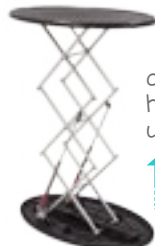

automatic hydraulic unfolding

EXTERNAL SIZE *mm ARTWORK DOWNLOAD

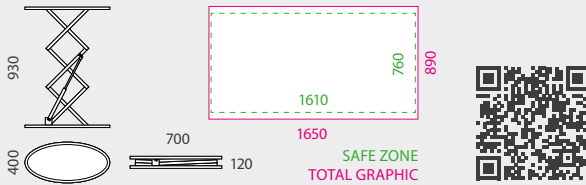

INFORMATION

Siena is lightweight and easy to fold and setup. With a hard carry padded bag and a double zip to the interior for storing. Features an **hydraulic drive system** for an automatic and quick unfolding with just a slight push on the top of the counter. Counter is ideal as a lectern or podium at tradeshows, promotional events or conventions and are great to pair with Pop Up banners or any stand.

SIENA	QTY	N.W	G.W	C.B.M	SIZE
Packing	1	5.6kg	7.6kg	0.21	970x600x360mm
15.244	Graphic Size: 890x1650mm				

* Custom textile printing in full color is available but not included.

SIENA

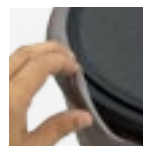
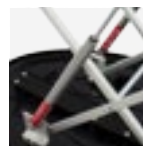

*Printed on textile.
Impression sur toile.
Impressão em tecido.
Impresión en tela.



MIKONOS



*Printed on textile.
Impression sur toile.
Impressão em tecido.
Impresión en tela.



EXTERNAL SIZES & DOWNLOADABLES ARTWORKS (QR CODE)

*mm

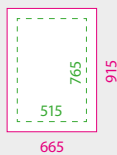
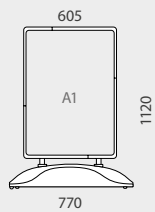

SAFE ZONE
TOTAL GRAPHIC



REF
15.243

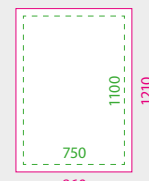
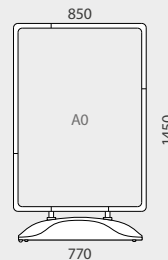

SAFE ZONE
TOTAL GRAPHIC



REF
15.242

INFORMATION

Mikonos features a lightweight aluminum structure with a refillable plastic base that assembles in seconds (It is 3.95kg weight and it can be filled with 17l of water). Also, the Textile Boards are also simple to setup. All the aluminium poles fit together and snap into base. Simply stretch the wrap over the completed base and it's ready to use. The aluminium structure is affixed to the base with 2 large springs, so it stays stable in windy conditions. Built-in wheels also make this board easy to move as needed. Carrying bag is included for an easy storage and transportation. Denote your business with the innovative design and versatility of textile printing. Ideal for trade shows or promotional events. The Mikonos outdoor board is ideal for being used at heavily-trafficked areas such as tradeshow, events, stores or malls.

MIKONOS AI	QTY	N.W	G.W	C.B.M	SIZE	
Packing	1	7.5kg	9.5kg	0.11	520x230x940mm	17 L
✿ 15.243	Graphic Size: 665x915mm					

* Custom textile printing in full color is available but not included.

MIKONOS AO	QTY	N.W	G.W	C.B.M	SIZE	
Packing	1	8kg	10kg	0.11	520x230x940mm	17 L
✿ 15.242	Graphic Size: 860x1210mm					

* Custom textile printing in full color is available but not included.

SPOTLIGHT
TENSION TEXTILE DISPLAY

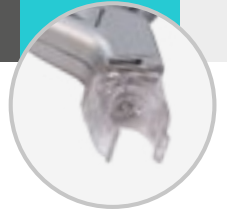

black or grey colored

SPOTLIGHT	QTY	N.W	G.W	C.B.M	SIZE
Packing	1	1kg	1.15kg	0.006	173x60x590mm
✿ 13.450	■	Power: 150 W			
✿ 13.451	■	Power: 150 W			

INFORMATION

*mm

Trade show display lighting adds the finishing touches needed to impress clients and to create effective presentations. This 150 W spotlight has a suitable fixing design for the tubular structures of the tension textile displays. Once in place, simply plug in the long cable to instantly add brightness. Stylish black or silver finish.

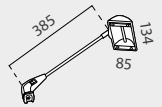

FASTENER PIECES FOR
TENSION TEXTILE DISPLAY

SILICON STRIP



13.452



13.453



INFORMATION

These connector parts are specially designed for the tubular aluminum structure, making it ideal for joining several Tension Textile Displays. Two different rotating types of connection according to the needs. Transparent finish for complete integration with the Tension Textile display.

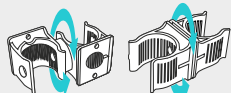

REF 13.452

REF 13.453

✿ 13.452

✿ 13.453

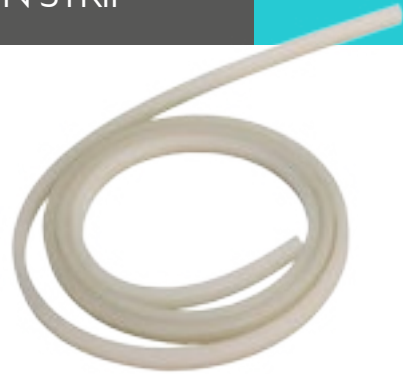

INFORMATION

*mm

Some Tension Textile Displays require that the set of textile graphics be made with a silicone around the perimeter so that these can be correctly introduced into their structures. This silicone is ideal for the manufacturing of textile for the Tension Display stands. It comes in 10m linear pack

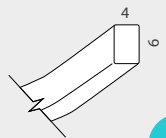

REF 13.465

✿ 13.465

Pack 10m/l

HANGING SIGNS



Hanging Signs



EN The Hanging Signs provide a great visual impact at long distance. With easy-assembly aluminium profiles and high-quality printed graphics where you can expose your message at height. Lightweight and easy to hang from the ceiling by wires. This system comes ready to be used anywhere. Supplied with mounting parts and carry bag.

FR Les Hanging Signs ont un grand impact visuel. Profils en aluminium, très faciles à monter, et impression de qualité sur toile tendue permettent l'exposition rapide de messages en hauteur. Léger et facile à suspendre, ce système est idéal pour tous les espaces.

PT Os Hanging Signs transmitem um grande impacto visual. Com perfis de alumínio e de montagem fácil, pode colocar uma mensagem em altura. Leve e fácil de pendurar, este sistema é adequado a qualquer espaço. Fornecido com peças de montagem e saco de transporte.

ES Los Hanging Signs aportan un gran impacto visual a larga distancia. Con perfiles de aluminio fáciles de montar y una gráfica impresa de alta calidad donde puedes situar un mensaje en altura. Ligeros y fáciles de colgar mediante cables del techo. Este sistema viene preparado para emplearlo en cualquier lugar. Se suministra con piezas de montaje y bolsa de transporte.

easy to hang from ceiling by wires



TEXTILE *Printed on textile. Impression sur toile. Impressão em tecido. Impresión en tela.

EXTERNAL SIZE

*mm

REF 15.227

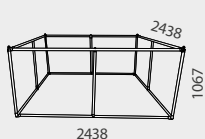

REF 15.228

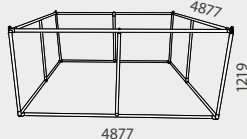

INFORMATION

This advertising overhead square banner can stand out anywhere. Use this hanging display to gain attention at conventions, even in a large exhibit hall, helping people locate a specific company or booth. Easy to hang from ceiling by wires. This entire display breaks down to fit into one bag for portability. Carry bag is included. The frame pieces easily pop into place for quick setup. Make a lasting impression at a convention with these displays. Two different sizes available.

SQUARE "S"	QTY	N.W	G.W	C.B.M	SIZE
Packing	1	10.5kg	13.6kg	0.1237	370x220x1520mm
15.227	S	External Size: 2438x1067mm			
SQUARE "M"	QTY	N.W	G.W	C.B.M	SIZE
Packing	1	16.3kg	19.7kg	0.14	370x220x1720mm
15.228	M	External Size: 4877x1219mm			

* Custom textile printing in full color is available but not included.

HANGING SIGN SQUARE



HANGING SIGN CIRCLE

easy and
fast assembly

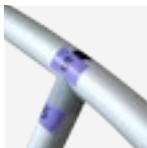
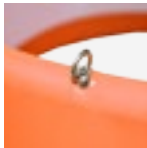

easy to hang from
ceiling by wires



*Printed on textile.
Impression sur toile.
Impressão em tecido.
Impresión en tela.

EXTERNAL SIZE

*mm

REF
15.229

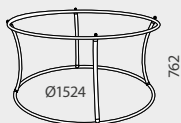

REF
15.230

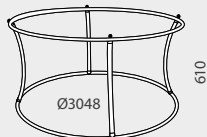

INFORMATION

This advertising overhead circular banner can stand out anywhere. Use this hanging display to gain attention at conventions, even in a large exhibit hall, helping people locate a specific company or booth. Easy to hang from ceiling by wires. This entire display breaks down to fit into one bag for portability. Carry bag is included. The frame pieces easily pop into place for quick setup. Make a lasting impression at a convention with these displays. Two different sizes available.

CIRCLE "S"	QTY	N.W	G.W	C.B.M	SIZE
Packing	1	5.5kg	7kg	0.0663	320x170x1220mm

 15.229  External Size: 1524x762mm

CIRCLE "M"	QTY	N.W	G.W	C.B.M	SIZE
Packing	1	16.3kg	19.7kg	0.14	370x220x1720mm

 15.230  External Size: 3048x610mm

* Custom textile printing in full color is available but not included.





HANGING SIGN TAPERED CIRCULAR

light weight
aluminium profiles



easy to hang from
ceiling by wires

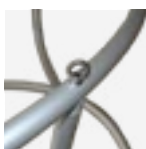
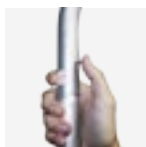
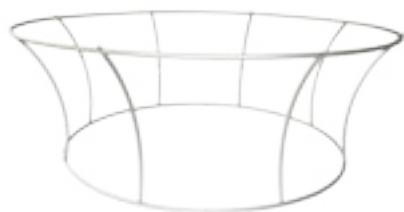

*Printed on textile.
Impression sur toile.
Impressão em tecido.
Impresión en tela.

EXTERNAL SIZE

*mm



REF
15.231



REF
15.232

INFORMATION

This advertising overhead tapered banner can stand out anywhere. Use this hanging display to gain attention at conventions, even in a large exhibit hall, helping people locate a specific company or tradebooth. Easy to hang from ceiling by wires. This entire display breaks down to fit into one bag (included) for portability. The frame pieces easily pop into place for quick setup. Make a lasting impression at a convention with these displays. Two different sizes available.

T. CIRCLE "S"	QTY	N.W	G.W	C.B.M	SIZE
Packing	1	9.8kg	12.9kg	0,14	370x220x1720mm

15.231	S	External Size: Ø3048/2438x1067mm			
--------	---	----------------------------------	--	--	--

T. CIRCLE "M"	QTY	N.W	G.W	C.B.M	SIZE
Packing	1	12.4kg	15.8kg	0,14	370x220x1720mm

15.232	M	External Size: Ø4627/3658x1219mm			
--------	---	----------------------------------	--	--	--

* Custom textile printing in full color is available but not included.



ROTATING STAND



4m

maximum height of 4m



3 plug adapters included

Ø 44mm aluminium pole

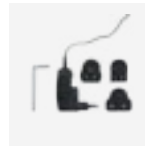

400x400mm steel base

rotating 360° motor



Fiberglass sticks



also height can be customized by adding or removing aluminium poles



*Printed on textile.
Impression sur toile.
Impressão em tecido.
Impresión en tela.

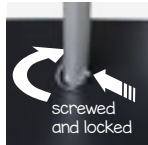

screwed and locked



EXTERNAL SIZE

ARTWORK

*mm

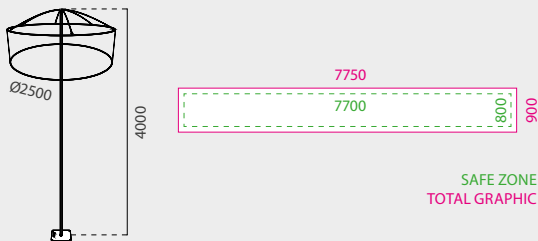

SAFE ZONE
TOTAL GRAPHIC

INFORMATION

The Rotating Stand provides a great visual impact at long distance. With easy-assembly aluminium poles and high-quality printed graphics where you can expose your message at height. This system comes ready to be used anywhere. Supplied with steel base, aluminium structure, fiberglass sticks, rotary 360° motor, power supply, plug adapters and carry bag. Use this display to gain attention at conventions or events, helping people locate a specific company or tradebooth.

ROTATING	QTY	N.W	G.W	C.B.M	SIZE
Packing	1	16.3kg	19.7kg	0.14	370x220x1720mm
15.254	Graphic Size: 7750x900mm				

* Custom textile printing in full color is available but not included.



PANEL BANNER VIDAGO

EN Magnetic Panel System. Using straight frames to which the graphic panel can be attached by means of magnetic strips.
 • 2 round steel bases. • 2 aluminum poles. • 2 spotlights. • Connectors.
 • 4 aluminum cases (700x1000mm). • 8 pieces of PS of panel.

FR Système de panneaux magnétiques.
 Affichage fixé sur cadre avec ruban magnétique.
 • 2 bases rondes en acier. • 2 poteaux en aluminium. • Connecteurs.
 • 4 cadres en aluminium (700x1000mm). • 8 pcs de panneau PS. • 2 foyers.

PT Sistema de painéis magnéticos. Os painéis são fixados nos marcos mediante barras magnéticas.
 • 2 bases redondas de aço. • 2 postes de alumínio. • 8 peças de painel PS.
 • 4 marcos de alumínio (700x1000mm). • 2 focos. • Conectores.

ES Sistema de panel magnético. Haciendo uso de marcos rectos a los cuales el panel gráfico puede unirse por bandas magnéticas.
 • 2 bases redondas de acero. • 2 postes de aluminio. • 8 pcs PS panel.
 • 4 marcos de aluminio (700x1000mm). • 2 focos. • Conectores.

spotlights included



2 round steel bases



INFORMATION

This exhibition display unit features 1 backdrop double-sided panel designed for 8 graphic panes. This unit can be easily assembled into an appealing pop up display thanks its magnetic system to fix the panes. Aluminium structure composed by 2 poles, 4 cases and 2 round bases made of steel. Also 2 spotlights are included. Pair this backdrop with some trade show fixtures available on this catalogue, such as counters, iPad mounts, chairs or brochure stands. The exhibition booths, offer a great way to market your business at trade shows, conventions, media events and expos.

EXTERNAL SIZE

ARTWORK *mm

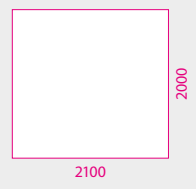
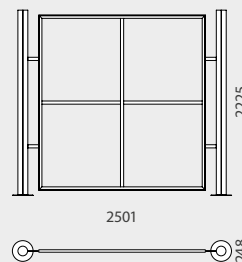

TOTAL GRAPHIC

VIDAGO	QTY	N.W	G.W	C.B.M	SIZE
Packing	1	34.5kg	35kg	0.40	800x400x1250mm
✳ 10.430		Graphic Size: 2100x2000mm			

CATANIA

EN Portable Display Wall. The construction makes an easy and fast assembly. Printing are not included.

- Aluminium Profile, base feet and two spotlights.
- Oxford Cloth bag: 1 unit.

FR Display portable, facile et rapide à monter. Visuel non inclus.

- Profils en aluminium, bases et foyers d'éclairage.
- Valise de transport Oxford Cloth: 1 unité.

PT Display portátil de fácil e rápida montagem. Material de impressão não incluído.

- Perfis de alumínio, bases e focos.
- Mala de transporte Oxford Cloth: 1 unidade.

ES Display portátil de fácil y rápido montaje. Impresión no incluida.

- Perfil de aluminio, bases y dos focos.
- Bolsa de transporte: 1 unidad.

spotlights included



denote your stand



1 oxford bag included

INFORMATION

This portable exhibition display unit features a lightweight, yet sturdy, aluminium profile structure. This unit can be easily assembled fast and easily. The entire portable display can be set up and taken down within minutes. It's composed by 1 aluminium frame structure, 2 round bases and 1 oxford bag for an easy transportation. Also 2 spotlights are included. Pair this backdrop wall with some trade show fixtures available on this catalogue, such as counters, iPad mounts, chairs or brochure stands. The exhibition booths, offer a great way to market your business at trade shows, conventions, media events or expos.

EXTERNAL SIZE

*mm

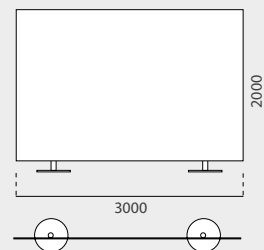

CATANIA	QTY	N.W	G.W	C.B.M	SIZE
---------	-----	-----	-----	-------	------

Packing	1	15kg	16.2kg	0.14	420x150x1250mm
---------	---	------	--------	------	----------------

 10.647 Size: 3000x2000mm

PERUGIA

EN Portable Display Wall. The construction makes an easy and fast assembly. Printing are not included.

- Aluminium Profile, base feet and two spotlights.
- Oxford Cloth bag: 1 unit.

FR Visuel portable, facile et rapide à monter. Visuel non inclus.

- Profils en aluminium, bases et foyers d'éclairage.
- Valise de transport Oxford Cloth: 1 unité.

PT Display portátil de fácil e rápida montagem. Material de impressão não incluído.

- Perfis de alumínio, bases e focos.
- Mala de transporte Oxford Cloth: 1 unidade.

ES Display portátil de fácil y rápido montaje. Impresión no incluida.

- Perfil de aluminio, bases y dos focos.
- Bolsa de transporte: 1 unidad.



2 spotlights included



Oxford bag included

INFORMATION

This portable exhibition display unit features a lightweight, yet sturdy, 2x3m aluminium profile structure. This unit can be easily assembled fast and easily. The entire portable display can be set up and taken down within minutes. It's composed by 1 aluminium frame structure, 2 round bases and 1 oxford bag for an easy transportation. Also 2 spotlights are included. Pair this backdrop wall with some trade show fixtures available on this catalogue, such as counters, iPad mounts, chairs or brochure stands. The exhibition booths, offer a great way to market your business at trade shows, conventions, media events or expos.

PERUGIA	QTY	N.W	G.W	C.B.M	SIZE
Packing	1	15kg	16.2kg	0.14	420x150x1250mm

 10.648 Graphic Size: 3000x2000mm

EXTERNAL SIZE

ARTWORK

*mm

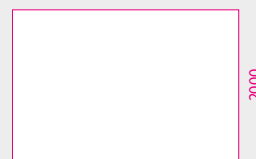
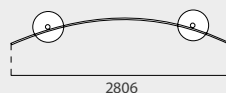

3000

TOTAL GRAPHIC

LIMOGES

- EN** Stable Exhibition System. Fast and easy assembly. Printing is not included.
- Aluminium frame 2000x2200mm. • Header Board. Shelves: 1.
 - Wings (2 units) (L&R). • V" Shape Table: 1. • Spotlights (2 units).
 - Plastic Packing Case.
- FR** Système d'exposition stable. Montage facile. Visuel non inclus.
- Cadre en aluminium 2000x2200mm. • Ailes (2 unités) (L&R).
 - Plaque supérieur Étagère: 1. • "Table en "V": 1.
 - Foyers d'éclairage (2 unités). • Valise en plastique.

- PT** Sistema de exibição estável. De fácil montagem. Impressão não incluída.
- Marco de alumínio 2000x2200mm. • Placa superior. Prateleira: 1.
 - Alas (2 unidades) (L&R). • Mesa em forma de "V": 1.
 - Focos (2 unidades). • Mala de transporte em plástico.
- ES** Sistema de exhibición estable de fácil montaje. Impresión no incluida.
- Marco de aluminio 2000x2200mm. • Placa superior. Estantes: 1.
 - 2 Alas (izquierda, derecha). • Mesa en forma de "V": 1.
 - 2 focos. • Maleta de plástico.



INFORMATION

This portable exhibition display unit features a lightweight, yet sturdy, 2x2m aluminium profile structure. This unit can be easily assembled fast and easily. The entire portable display can be set up in a few minutes. It's composed by 1 aluminium frame structure, 2 round bases, 1 header board, 2 sides wings, 1 shelf, 1 "V" table, 2 spotlights and 1 hard case. Pair this backdrop wall with some trade show fixtures available on this catalogue, such as counters, iPad mounts, chairs or brochure stands. The exhibition booths, offer a great way to market your business at trade shows, conventions, media events or expos.

LIMOGES	QTY	N.W	G.W	C.B.M	SIZE
---------	-----	-----	-----	-------	------

Packing	1	52.5kg	54kg	0.44	780x390x1450mm
---------	---	--------	------	------	----------------

10.153

EXTERNAL SIZE

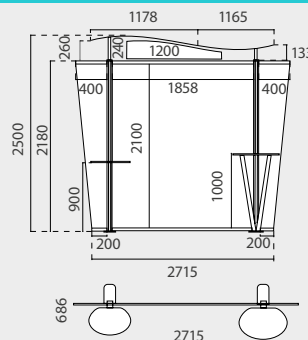

ARTWORK

*mm

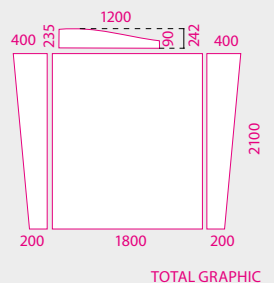

OPOLE

- EN** Stable Exhibition System. Easy to be assembled. Printing is not included.
- Aluminium frame 2850x2200mm. • Header Board. Shelves: 3.
 - Wings (2 units) (L&R). • "V" Shape Table: 1. • Spotlights (3 units).
 - Plastic Packing Case.
- FR** Système d'exposition stable. Montage facile. Visuel non inclus.
- Cadre en aluminium 2850x2200mm. • Ailes (2 unités) (L&R).
 - Plaque supérieur. Étagères: 3. • Table en "V": 1.
 - Foyers d'éclairage (3 unités). • Valise en plastique: 1 unité.

- PT** Sistema de exibição estável. De fácil montagem. Impressão não incluída.
- Marco de alumínio 2850x2200mm. • Placa superior. Prateleiras: 3.
 - Alas (2 unidades) (L&R). • Mala de transporte em plástico: 1.
 - Mesa em forma de "V": 1. • Focos (3 unidades). Fixador de LCD.
- ES** Sistema de exhibición estable. Fácil montaje. Impresión no incluida.
- Marco de aluminio 2850x2200mm. • Placa superior. Estantes: 3.
 - 2 Alas (izquierda, derecha). • Mesa en forma de "V": 1.
 - 3 focos. • Maleta de plástico.



INFORMATION

Opole is a portable and elegant exhibition display unit formed by a sturdy, 2850x2200mm aluminium structure. This unit can be easily assembled fast and easily. The entire portable display can be set up in a few minutes. It's composed by 1 aluminium frame structure, 1 header board, 2 sides wings, 3 shelves, 1 "V" table, 3 spotlights and 1 hard case. Pair this backdrop wall with some trade show fixtures available on this catalogue, such as counters, iPad mounts, chairs or brochure stands. The exhibition booths, offer a great way to market your business at trade shows, conventions, media events or expos.

OPOLE	QTY	N.W	G.W	C.B.M	SIZE
Packing	1	63.5kg	65kg	0.441	780x390x1450mm
10.192					

EXTERNAL SIZE

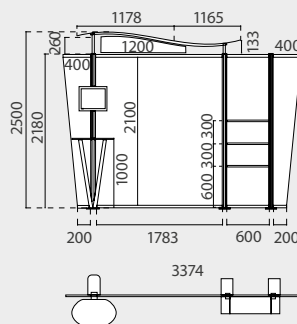

ARTWORK

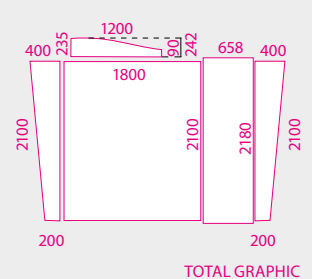

KASSEL

EN Smart Exhibition System. Easy to be assembled. Printing is not included.
 • Aluminium frame 2824x2400mm. • Header Board. • Counter.
 • Shelves: 3. • Spotlights (3 units). • Plastic Packing Case.

PT Sistema de exibição de fácil montagem. Impressão não incluída.
 • Marco de alumínio 2824x2400mm. • Prateleiras: 3.
 • Mala de transporte em plástico. • Focos (3 unidades). • Balcão.

FR Système d'exposition stable. Montage facile. Visuel non inclus.
 • Cadre en aluminium 2824x2400mm. • Plaque supérieur. • Comptoir.
 • Étagères: 3. • Foyers d'éclairage (3 unités). • Valise en plastique.

ES Sistema de exhibición elegante y estable de fácil montaje. Impresión no incluida.
 • Marco de aluminio 2824x2400mm. • Placa superior.
 • Maleta de transporte de plástico. • Estantes: 3. • 3 focos. • Mostrador.

includes 3 spotlights

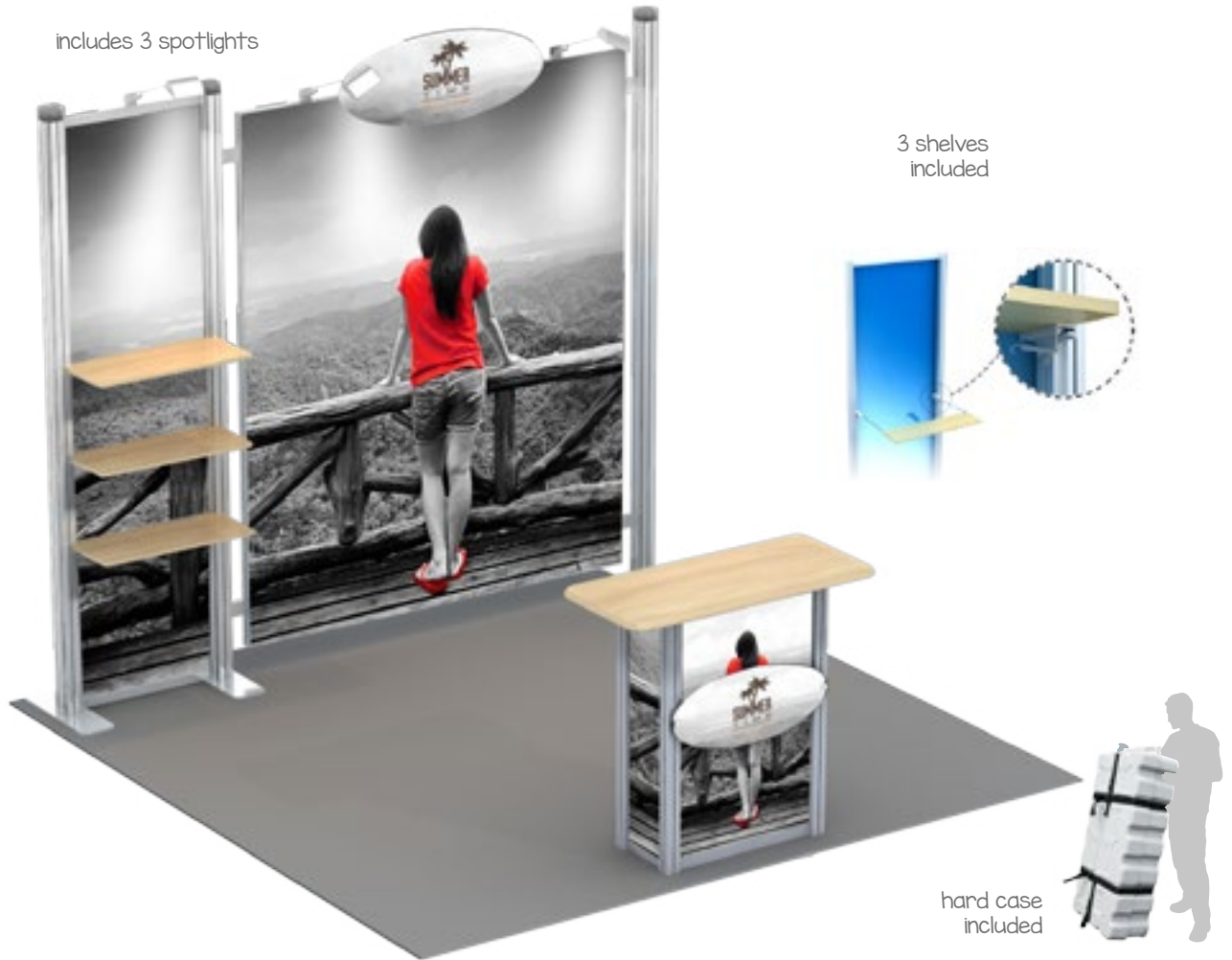

INFORMATION

Kassel is a portable and elegant -All in one- trade show booth unit formed by a sturdy, 2824x2400mm aluminium structure. This unit can be easily assembled fast and easily. The entire portable display can be set up in a few minutes. It's composed by 1 aluminium frame structure, 1 header board, 3 shelves, 1 counter, 3 spotlights and 1 hard case. Pair this tradebooth with some trade show fixtures available on this catalogue, such as Totems, iPad mounts, chairs or brochure stands. The exhibition booths, offer a great way to market your business at trade shows, conventions, media events or expos.

KASSEL QTY N.W G.W C.B.M SIZE

Packing 1 85.5kg 86.95kg 0.441 780x390x1450mm

10.364

EXTERNAL SIZE

ARTWORK

*mm

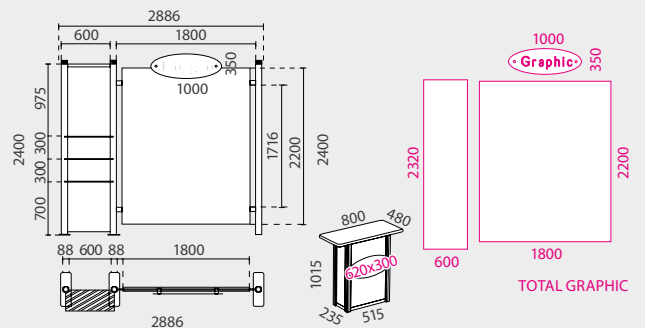

PESCARA

- EN Flexible Pop-Up wall system. Easy assembly. Printing is not included.
 • Straight Pop-Up Frame for 3x1: 3 units. • Corner Accessories: 3 units.
 • Plastic trolley Case: 2 units.
- FR Pop-Up magnétique facile à monter. Visuel non inclus.
 • Pop-Up 3x1: 3 unités. • Accessoires pour les angles: 3 unités.
 • Valise de transport en plastique: 2 unités.

- PT Pop-Up magnético de fácil montagem. Impressão não incluída.
 • Pop-Up 3x1 recto: 3 unidades. • Acessórios das esquinas: 3 unidades.
 • Mala de transporte em plástico: 2 unidades.
- ES Sistema de Pop-Up flexible y de fácil montaje. Impresión no incluida.
 • Estructura recta de Pop-Up 3x1: 3 unidades.
 • Accesorios para esquinas: 3 unidades. • 2 Maletas de plástico.

3 spaces divided to expose

2 trolley cases included



easy to assemble



INFORMATION

Pescara is a flexible 3-walls booth graphics system made up of a Pop-up structure to create an impressive triple spaced trade show booth. With a top height of 2340mm, this event fixture features enough space for setting up counters, chairs or any display and create 3 conference environments for your bussines. Ideal for meeting one-on-one with potential customers at a trade show. Composed by a straight frame for 3 graphic sides and 3 corner accessories. The portable display breaks down quickly, fitting neatly into the 2 portable carrying bags (included) to transport back to your business or to the next event. The 2 trolley cases are made of heavy-duty molded plastic and features roller wheels, dual handles, and locking security.

PESCARA	QTY	N.W	G.W	C.B.M	SIZE
Packing	1	68.5kg	70kg	0.31	730x430x1010mm
				0.31	730x430x1010mm

10.639

EXTERNAL SIZE & ARTWORK

*mm

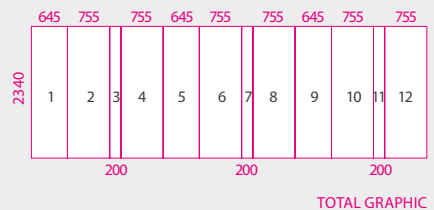
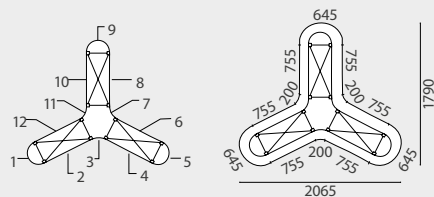

FLORENCIA

- EN Flexible Pop-Up wall system. Easy assemble. Printing is not included.
 • Straight Pop-Up Frame 3x3: 1 unit / Straight Pop-Up frame 3x2: 2 units.
 • Accessories corners: 3 units. • Spotlights: 2 units. • Trolley Cases: 2 units.
- FR Pop-Up magnétique facile à monter. Visuel non inclus.
 • Pop-Up 3x3: 1 unité. / Pop-Up 3x2: 2 unités. • Foyer d'éclairage: 2 unités.
 • Accessoires pour les angles: 3 unités. • Valise de transport : 2 unités.

- PT Pop-Up magnético de fácil montagem. Impressão não incluída.
 • Pop-Up 3x3 recto: 1 unid. / Pop-Up 3x2 recto: 2 unid. • Focos: 2 unid.
 • Acessórios das esquinas: 3 unidades. • Mala de transporte: 2 unidades.
- ES Sistema de Pop-Up flexible y de fácil montaje. Impresión no incluida.
 • Estructura recta de 3x3: 1 unidad / 3x2 recto: 2 unidades. • 2 focos.
 • Accesorios para esquinas: 3 unidades. • 2 Maletas tipo Trolley.

2 spotlights are included

easy to assemble

2 trolley cases included

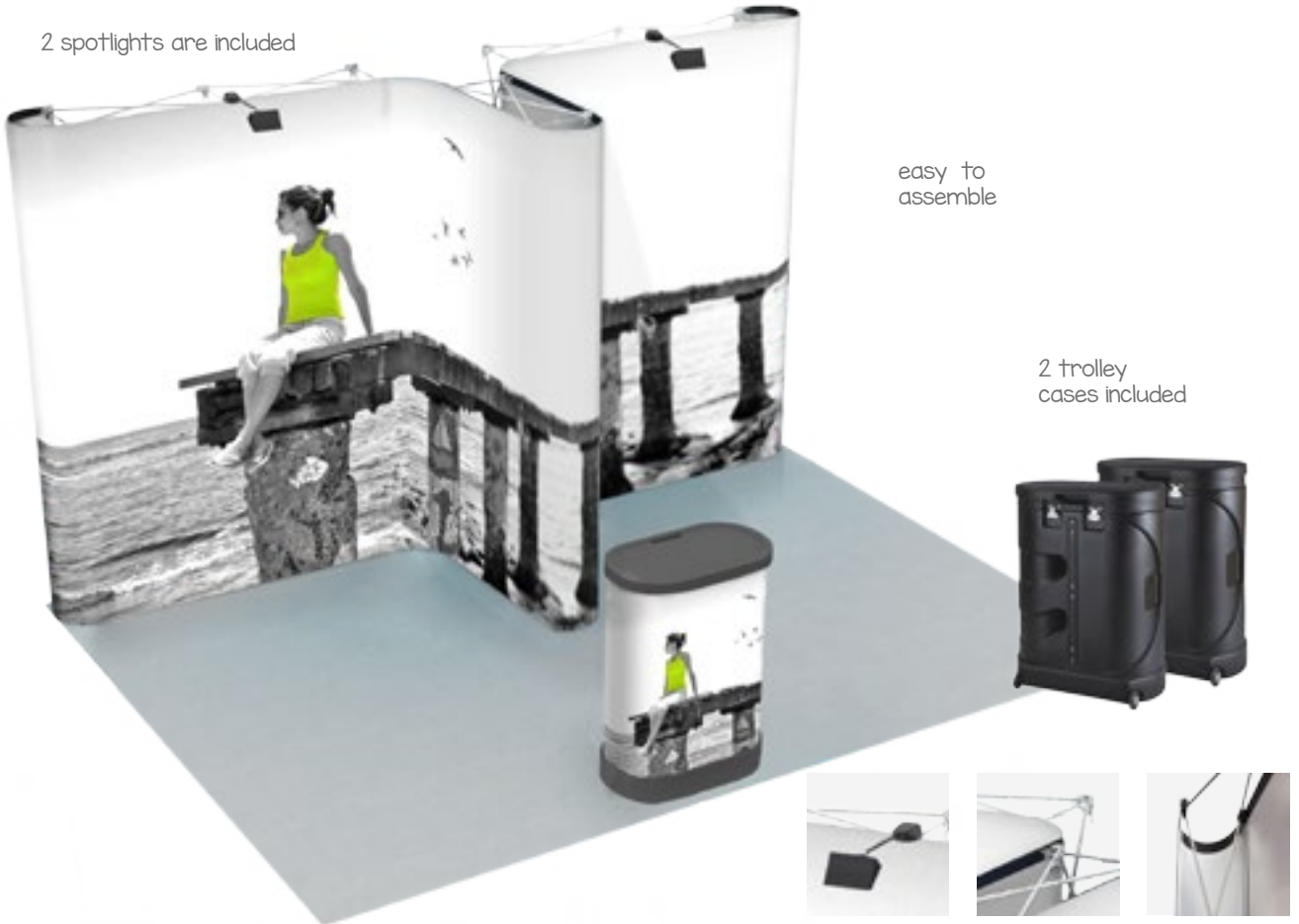

INFORMATION

Florencia is a flexible 3-walls booth graphics system made up of a Pop-up structure to create an impressive triple spaced trade show booth. With a top height of 2340mm, this event fixture features enough space for setting up counters, chairs or any display and create 2 conference environments for your bussines. Ideal for meeting one-on-one with potential customers at a trade show. Composed by a straight 3x3 frame, two 3x2 straight frames, 3 corner accessories and 2 spotlights. The portable display breaks down quickly, fitting neatly into the 2 portable carrying bags (included) to transport back to your business or to the next event. The 2 trolley cases are made of heavy-duty molded plastic and features roller wheels, dual handles, and locking security.

FLORENCIA	QTY	N.W	G.W	C.B.M	SIZE
Packing	1	83kg	85.5kg	0.31	730x430x1010mm
				0.31	730x430x1010mm

10.644

EXTERNAL SIZE & ARTWORK

*mm

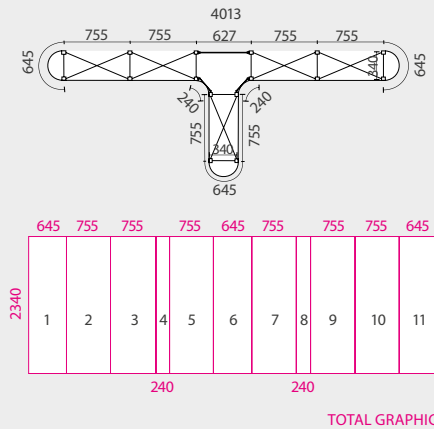

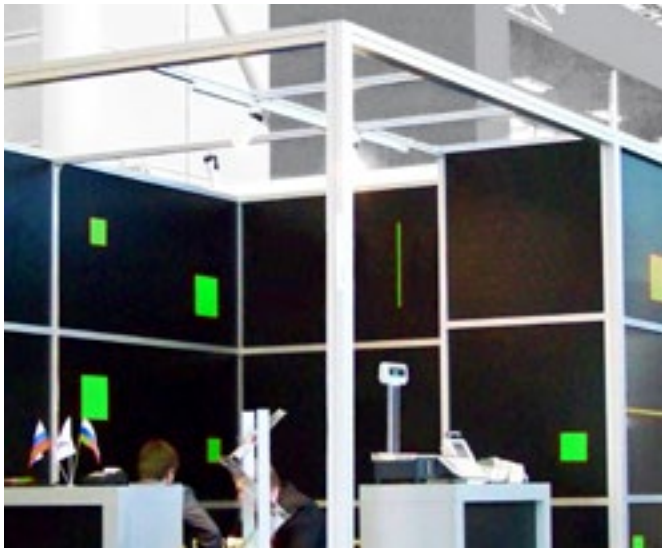

PROFILE STAND 100mm

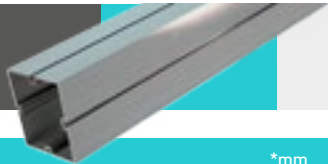

INFORMATION

*mm

Aluminum profile for the assembly of exhibition stands. Profile dimensions: 100x100mm.

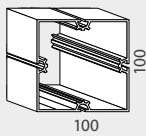

15.116 100mm

PROFILE STAND 40mm



INFORMATION

*mm

Aluminum profile for the assembly of exhibition stands. Profile dimensions: 40x40mm.

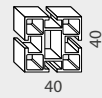

15.118 40mm

ALUMINIUM CONNECTOR FOR PROFILE 100mm



INFORMATION

*mm

- 1. Place the connector.
- 2. Adjust the connector into the aluminium profile.

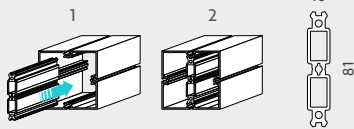

15.117 Connector 100mm

LOCK



INFORMATION

*mm

Use 1 lock for 40mm profile and 2 locks for 100mm profile.

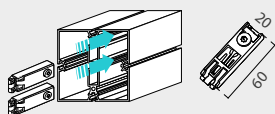

LOCK 2 Lock for 100mm 1 lock for 40mm

15.119 x2 

PLASTIC PIECES FOR TENSION GRAPHICS

attach your canvas to the profile system

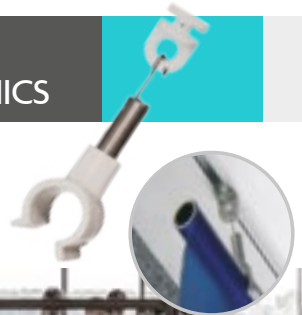

15.723 x 10 

- EN Fixing system for glass or acrylic performing stand. It's used for 100mm aluminium profile. Material: Steel.
- FR Système de fixation modulable pour vitres ou acryliques permettant le montage de stands. S'utilise avec un profil stand de 100mm.
- PT Sistema de fixação de vidros ou acrílicos para a montagem de stands. Utiliza-se com um perfil de 100mm. Material: Aço.
- ES Sistema de fijación de cristales o acrílicos para la realización de stand. Se utiliza con el profile stand de 100mm. Material: Acero.

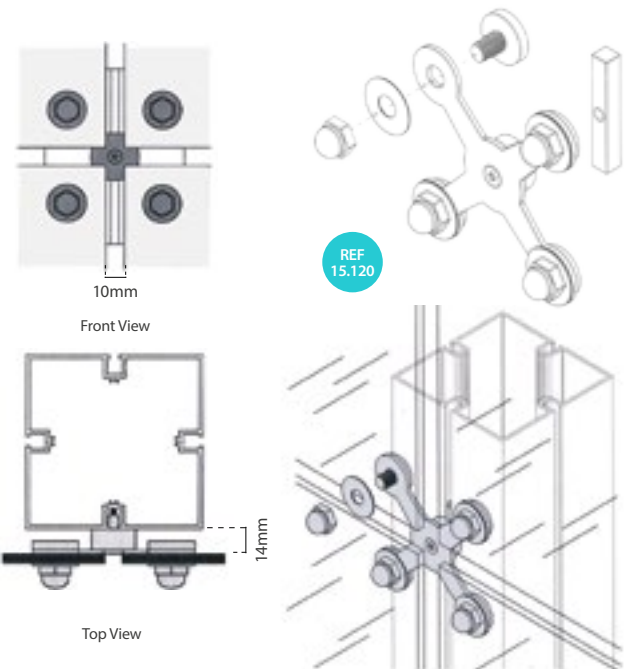
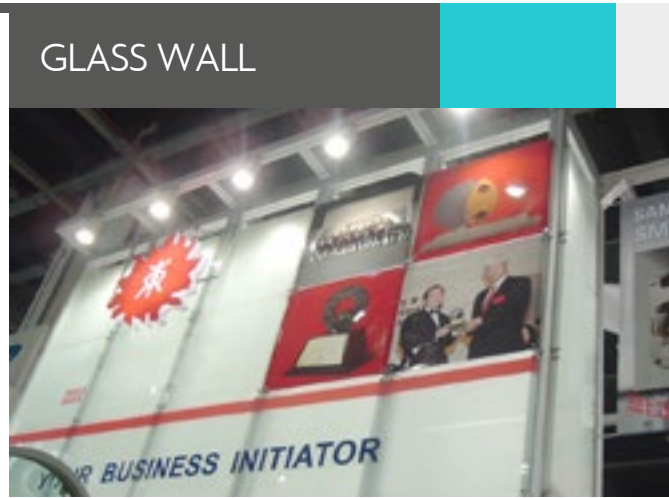

INFORMATION

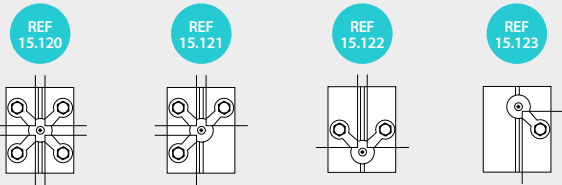

HOLES TEMPLATE *mm

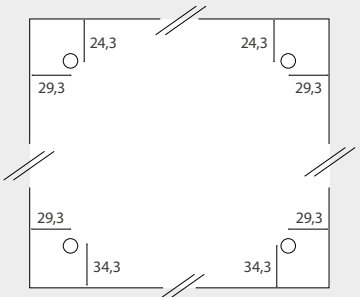

Dimensions for holes on glass or acrylic. / Dimensions pour le cristal ou l'acrylique. Medidas para furos em vidro ou acrílico. / Medidas para agujeros en cristal o acrílico.

GLASS WALL	PARTS
15.120	4 Parts
15.121	3 Parts
15.122	2 Parts
15.123	1 Part



ALUMINIUM TRUSS | Aluminium Truss "DUO"

EN Light weight, high strength and easy assembly aluminium structure.

FR Structure d'aluminium. Poids léger, grande résistance, montage facile.

PT Estrutura em alumínio. Leve, de grande resistência e fácil montagem.

ES Estructura de aluminio de peso ligero, gran resistencia y fácil montaje.

EN Aluminium Truss "Duo" formed by 2 aluminum bars, color "natural silver."

FR Colonne de Truss "Duo" formée par 2 barres d'aluminium couleur "argent naturel".

PT Coluna Truss "Duo" formada por 2 barras de alumínio em cor prateada.

ES Larguero de Truss "Duo", formado por 2 barras de aluminio, color "plata natural".



TRUSS DUO

SIZE

15.305	500mm	
15.060	1000mm	
15.063	1500mm	
15.066	2000mm	
15.306	2500mm	
15.307	3000mm	

ALUMINIUM TRUSS "DUO"

light weight
and high strength

 easy
assembly



Formed by 2
aluminium bars



STANDARD SIZES

*mm

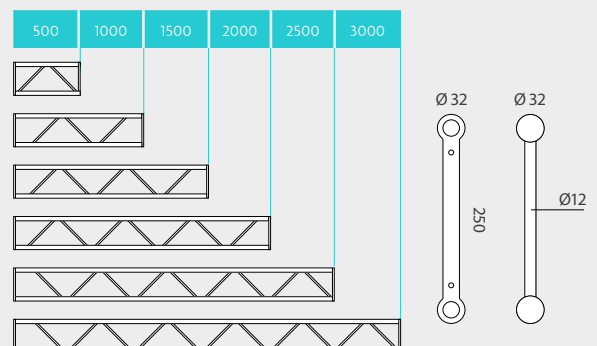

ALUMINIUM TRUSS "DUO" CONNECTOR

REF
15.068

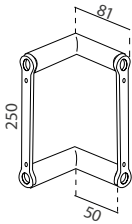

REF
15.069

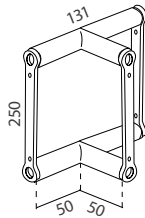

REF
15.070

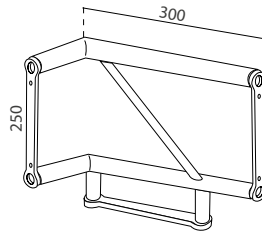



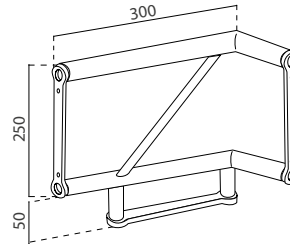

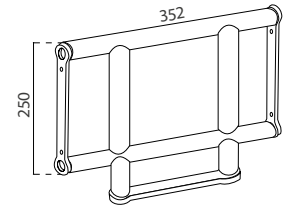

REF
15.071



REF
15.072



STANDARD SIZES

CONNECTOR	SIZE	
15.068	2 connection sides	
15.069	3 connection sides	
15.070	3 connection sides	
15.071	3 connection sides	
15.072	3 connection sides	
15.073	4 connection sides	
15.074	4 connection sides	

light weight
and highly
resistant

REF
15.073

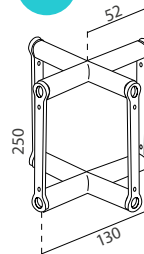

REF
15.074

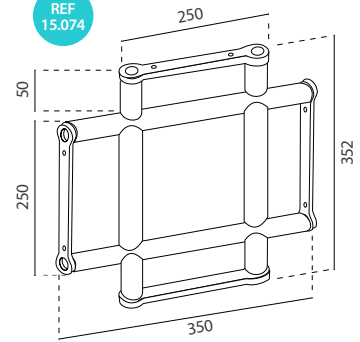

STEEL SCREWS FOR ALUMINIUM TRUSS

EN	Steel screws for mounting the aluminum Truss. Nut is supplied.
FR	Vis en acier pour le montage du Truss aluminium. Vis fournit avec son écrou.
PT	Parafuso com porca para estrutura Truss em alumínio. Fabricado em aço.
ES	Tornillería en acero para el montaje de Truss de aluminio. Se suministra con tuercas.



SCREWS T.	SIZE
15.040	44x11mm

INSTALL EXPLANATION

*mm

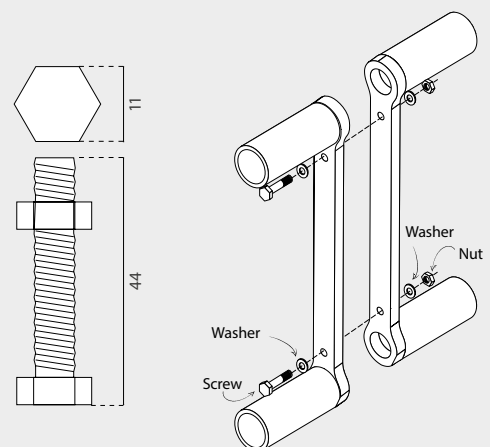



ALUMINIUM TRUSS "SHOW"

light weight and great resistance



with accessories

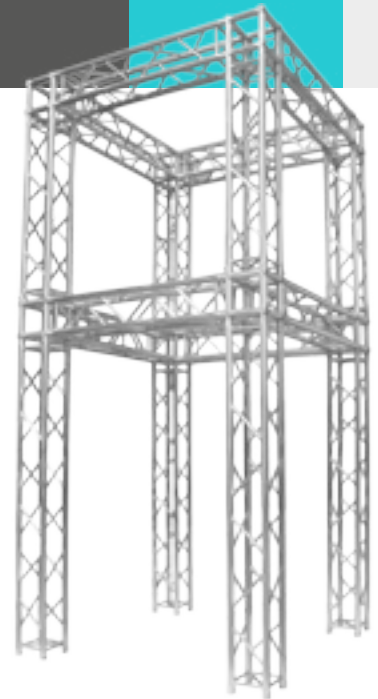
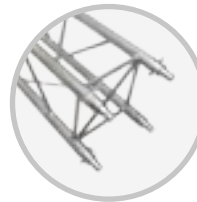

EN	Vertical aluminium Truss, 32 mm diameter. Ideal for producing and assembling a booth, venues, outdoor events, placing graphics, etc. It is characterized by its great resistance, lightweight and easy assembly. Color: natural silver.
FR	Colonne de Truss fabriquée en aluminium, couleur "argent naturel" avec tubes de 32mm de diamètre. Idéal pour la réalisation et le montage de stands, scènes, événements extérieurs, suspension de bâches, etc. Léger, résistant et facile à monter.
PT	Colunas Truss fabricadas em alumínio, em cor prateada, com tubos de 32mm de diâmetro. Ideal para a realização e montagem de stands, cenários, eventos ao ar livre, colocação de lonas, entre outros. Caracteriza-se pela sua grande resistência, leveza e fácil montagem.
ES	Largueros Truss, fabricados en aluminio, color "plata natural", con tubos de 32mm de diámetro. Ideal para realización y montaje de stands, escenarios, eventos al aire libre, colocación de lonas, etc. De gran resistencia, peso ligero y fácil montaje.

"SHOW"	SIZE	500	750	1000	1500	2000	2500	3000
* 15.301	500x250mm							
* 15.302	750x250mm							
* 15.141	1000x250mm							
* 15.143	1500x250mm							
* 15.145	2000x250mm							
* 15.303	2500x250mm							
* 15.304	3000x250mm							

MAIN TUBES	Ø32x1.2mm
BRACES	Ø12x1.0mm
MATERIAL	Alloy En-Aw 6005 T6
WEIGHT	1.84 kg/m

EN	Connectors for joining Truss spars. Produced in aluminum and "natural silver" color.
FR	Cubepour l'union de colonnes de Truss. Fabriqué en aluminium est de couleur "argent naturel".
PT	Cubos de união para colunas Truss fabricados em alumínio de cor prateada.
ES	Cubos para unión de largueros de Truss. Fabricados en aluminio y color "plata natural".

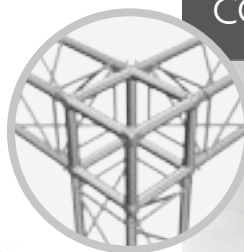

For joining Truss spars



CONNECTOR TRUSS

CONNECTOR T.	SIZE
* 15.147	250x250x250mm



ALUMINIUM TRUSS | Accessories for Connecting Truss "Show"

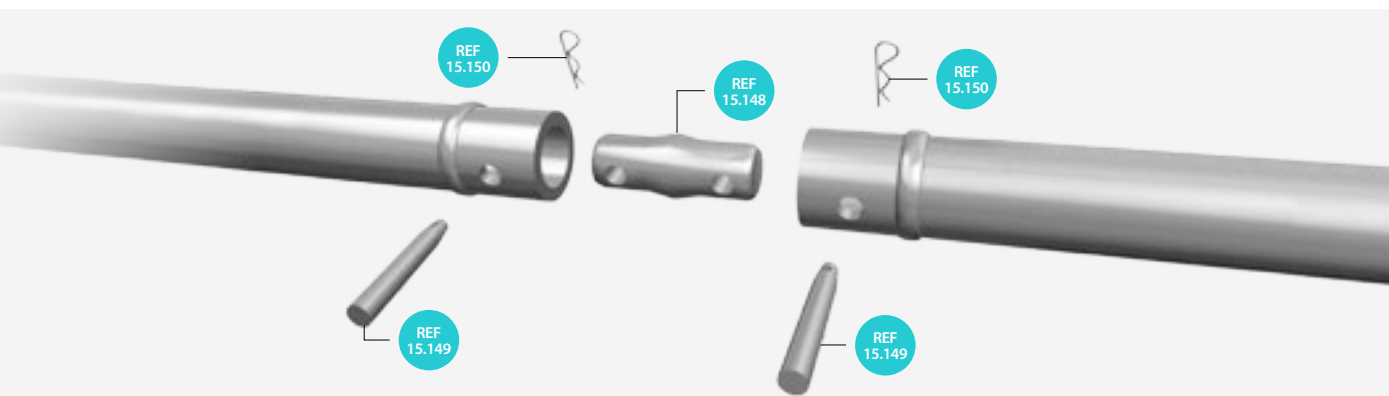

CONICAL CONNECTOR

INFO

Conical connector for joining Truss bars.

* 15.148

HALF CONICAL CONNECTOR

INFO

Conical semiconnector for joining Truss bars + bolt.

* 15.151

PIN

INFO

Pin for the connection of Truss bars

* 15.149

SAFETY CLIP

INFO

Clip to secure the connection of Truss bars

* 15.150

BASE FOR ALUMINIUM TRUSS "SHOW"

INFO



Steel base for aluminium Truss "Show".

* 15.300 300x300mm

300mm

300mm

INSTALL EXPLANATION

x4  x8  x8 

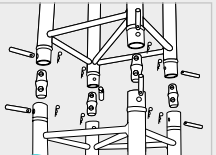
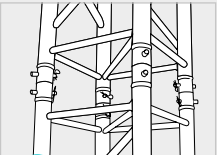
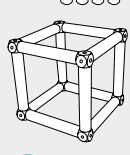
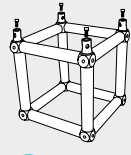
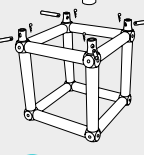
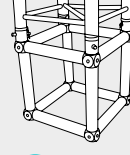
1  2  1  2  3  4 



- EN Modular floor system, quick and easy to assemble. Available in 5 different colors.
- FR Système de sol modulaire, facile et rapide à monter. Plusieurs couleurs disponibles.
- PT Sistema de chão modular de fácil e rápida montagem. Disponível em várias cores.
- ES Sistema de suelo modular fácil y rápido de montar. Disponible en varios colores.

COLOR FLOOR SYSTEM

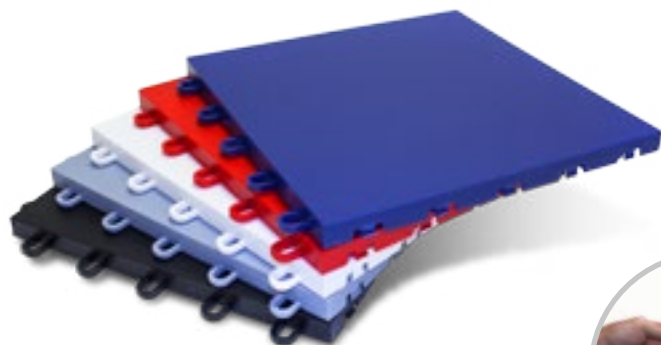

COLOR FLOOR SYSTEM

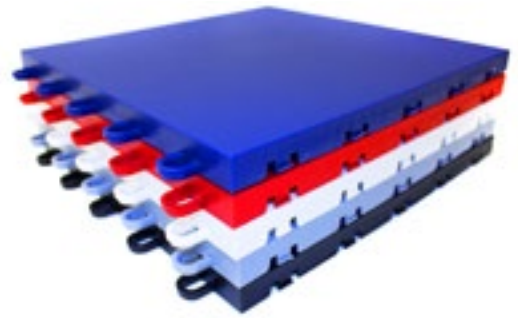
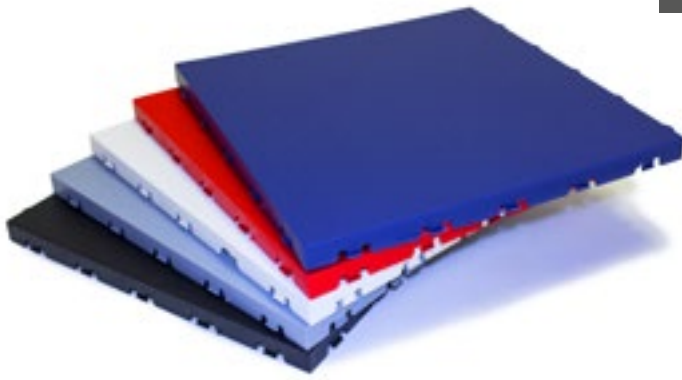

INFORMATION

Snap together these plastic interlocking floor tiles for an easy install and quick setup. Flooring made of high impact material results in long term use and dependability. Beneath each of the floor tiles there are ribbed support pillars for impact and shock absorption. Whether the 250x250mm configuration is used in a trade show booth exhibit, these multi-purpose floor tiles are suitable for indoor or outdoor events. Each unit with the reinforced composition provides a strong foundation efficient for impact and shock absorption. Ideal for a trade show booth set up. 5 colors available.

EXTERNAL SIZE

*mm

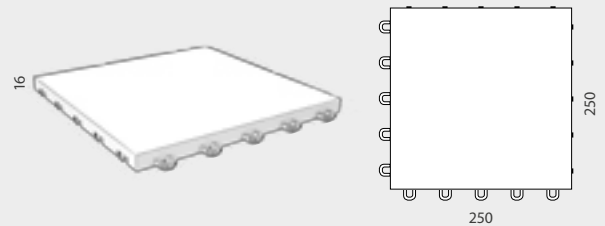

15.209  x16  (1m²)

FRAME AND CORNER COLOR FLOOR SYSTEM



REF 15.210



REF 15.211



REF 15.212

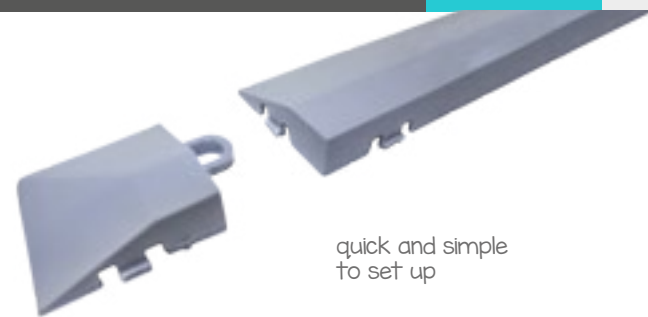





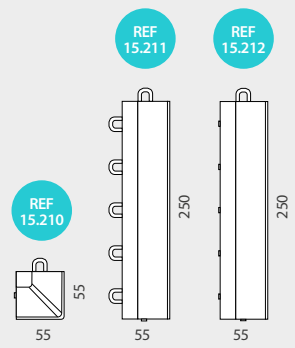

quick and simple to set up

EXTERNAL SIZES

*mm

Flooring construction is made easy with the clip and loop plastic tiles which allow each component to snap together without any tool. Create a finished and clean look by adding the sloped edge and mitered corner attachments to the perimeter for a smooth transition into a trade show booth. Each unit with the reinforced composition provides a strong foundation efficient for impact and shock absorption. Ideal for a trade show booth set up. 5 colors available.



15.210		Corner x4 
15.211		Frame Male x8 
15.212		Frame Female x8 

CAMIN

NEW

EN High Bar stool made of Polypropylene plastic and chromed structure.

FR Tabouret en plastique Polypropylène avec structure finition chromée.

PT Banco alto de plástico Polipropileno com estrutura cromada.

ES Taburete alto fabricado en plástico Polipropileno y estructura cromada.



CAMIN	QTY	N.W	G.W	C.B.M	SIZE
Packing	1	10.7kg	11.07kg	0.052	460x300x420mm
31.284	<input type="checkbox"/>				
	<input type="checkbox"/>				

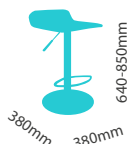

MONET

EN High Bar stool of chromed structure and ABS plastic seat. Pressure lever for optimal height adjustment.

FR Tabouret fabriqué en plastique, avec piston à gaz, repose-pieds et structure chromée.

PT Banco alto de plástico com estrutura cromada. Sistema de elevação a gás.

ES Taburete alto fabricado en plástico y estructura cromada. Sistema de elevación a gas.



REF 31.031

REF 31.033

MONET	QTY	G.W	C.B.M	SIZE
Packing	2	14.6kg	0.088	420x410x515mm
31.031	<input type="checkbox"/>			
31.032	<input type="checkbox"/>			
31.033	<input type="checkbox"/>			



EN High Bar stool of chromed structure and ABS seat. Pressure lever for height adjustment.

FR Tabouret fabriqué en plastique, avec piston à gaz, repose-pieds et structure chromée.

PT Banco alto de plástico com estrutura cromada. Sistema de elevação a gás.

ES Taburete alto fabricado en plástico y estructura cromada. Sistema de elevación a gas.

TIEPOLO

with adjustable height

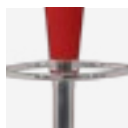

TIEPOLO	QTY	G.W	C.B.M	SIZE
Packing	2	14.3kg	0.170	570x490x610mm
31.043	<input type="checkbox"/>			
31.044	<input type="checkbox"/>			
31.045	<input type="checkbox"/>			



REF 31.043

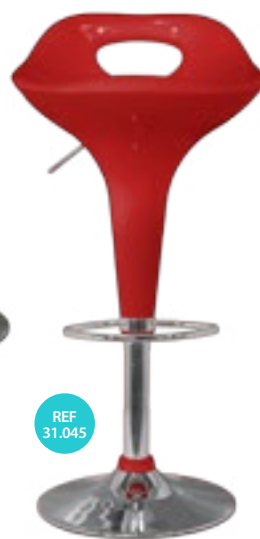

REF 31.045



REF 31.044

MISTRAL

NEW

- EN Chair with four-legged chromed frame and Polypropylene seat.
- FR Chaise avec structure finition chromée. Assise en Polypropylène.
- PT Cadeira com estrutura cromada, e assento em Polipropileno.
- ES Silla blanca de estructura cromada, con asiento de Polipropileno.



MISTRAL	QTY	N.W	G.W	C.B.M	SIZE
Packing	1	16.6kg	18.2kg	0.123	570x570x540mm
31.281	<input type="checkbox"/>				
	<input type="checkbox"/>				

BORGES

NEW

- EN Chair with four-legged beech frame, back and seat in Polypropylene.
- FR Chaise avec structure finition chromée. Assise en Polypropylène.
- PT Cadeira com estrutura cromada, e assento em Polipropileno.
- ES Silla de estructura de madera, respaldo y asiento de Polipropileno.

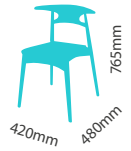

BORGES	QTY	N.W	G.W	C.B.M	SIZE
Packing	1	4.1kg	5.2kg	0.1238	780x560x170mm
31.280	<input type="checkbox"/>				
	<input type="checkbox"/>				

MARTI

NEW

- EN High Bar stool made of Polypropylene plastic and chromed structure.
- FR Tabouret en Polypropylène avec structure finition chromée.
- PT Banco alto de plástico. Com estrutura cromada.
- ES Taburete alto fabricado en plástico y estructura cromada.



MARTI	QTY	N.W	G.W	C.B.M	SIZE
Packing	1	22.5kg	23.6kg	0.23	570x460x850mm
31.283	<input type="checkbox"/>				
	<input type="checkbox"/>				

DELMAR

NEW

- EN High Bar stool made of Polypropylene plastic and wooden structure.
- FR Tabouret en plastique Polypropylène avec structure en bois.
- PT Banco alto de plástico Polipropileno com estrutura de madeira.
- ES Taburete alto fabricado en plástico Polipropileno y estructura de madera.



DELMAR	QTY	N.W	G.W	C.B.M	SIZE
Packing	1	4.6kg	5.9kg	0.064	780x450x200mm
31.282	<input type="checkbox"/>				
	<input type="checkbox"/>				

RUBENS

EN	Bar table. It is made of ABS and steel chrome.
FR	Table de bar en ABS avec structure chromée.
PT	Mesa alta com estrutura cromada e tampo de ABS
ES	Mesa alta con estructura cromada y tablero de ABS.

ideal for shows and exhibitions



RUBENS	QTY	G.W	C.B.M	SIZE
Packing	1	8.1kg	0.108	620x200x620mm 180x180x990mm
31.038	<input checked="" type="checkbox"/>			
31.037	<input type="checkbox"/>			

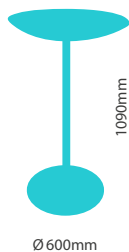

FROST

EN	Bar table. It is made of ABS and steel chrome.
FR	Table de bar en ABS avec structure chromée.
PT	Mesa alta com estrutura cromada e tampo de ABS
ES	Mesa alta con estructura cromada y tablero de ABS.

ideal for shows and exhibitions



FROST	QTY	N.W	G.W	C.B.M	SIZE
Packing	1	6.5kg	7.8kg	0.077	620x200x620mm
31.286	<input type="checkbox"/>				
	<input checked="" type="checkbox"/>				





iviceversa
Soluciones
Gráficas

Soluciones
Gráficas

Avd. de Elda, 72 · 03610 · Petrer (Alicante)
info@iviceversa.com · 670 37 70 13 · www.iviceversa.com

